

Water Management Product Catalog



THE MOST **ADVANCED** NAME IN WATER MANAGEMENT SOLUTIONS™



TABLE OF CONTENTS

PRODUCT APPLICATIONS

Matrix of appropriate applications for all products 2-3

PIPE

High Performance

• Sanitary / Storm 4-5

Dual Wall

• Characteristics. 6

• Low Head Water Transmission. 7

• Storm Drainage 8-13

Single Wall

• Characteristics. 14

• Storm Drainage 15-19

Smooth Wall, Triplewall. 20

PRESSURE PIPE

• PolyFlex™ Potable Grade 21-22

• PolyFlex™ Utility Grade 23

• PolyFlex™ Copper Tubing Size 24

FITTINGS

• Dual Wall 25-46

• INSERTA TEE® 47-48

• INSERTA TEE® Hole Saws 49

• Single Wall 50-56

• Turf Flow® 56

• PVC Fittings 57

NYLOPLAST®

• Road/Highway Structures. 58

• Catch Basins 59

• Grates. 60

• Water Control Structures 61

• Add-A-Branch. 61

• Fittings 62-67

HICKENBOTTOM® RISERS & PRECISION INTAKES . . . 68-69

OUTFLOW ACCESSORIES 70-71

RETENTION/DETENTION SYSTEMS 72-75

• StormTech® 76-86

STORM WATER TREATMENT

• Storm Water Quality Unit 87

• Grease Interceptor 87

• FLEXSTORM® Inlet Filters 88-92

• BaySaver® Storm Water Treatment 93

DURASLOT® 94-97

ADVANEDGE® 98-99

ONSITE CHAMBERS. 100-101

SEPTIC STACK™ 102

WASTE WATER ACCESSORIES 103

FOUNDATION DRAINAGE & ACCESSORIES. 104

METER PITS & WATERSTOP GASKETS 105

GEOSYNTHETICS

• Nonwovens. 106

• Wovens. 107

• Geogrids. 107

• Septic Fabrics 108

• Erosion Control Blankets 109

• Turf Reinforcement Mats 109

• Silt Fence 109



RESALE ITEMS – MARKED WITH  – ARE PRODUCTS OFFERED FOR SALE BUT NOT MANUFACTURED BY ADS/HANCOR.

STANDARD AND METRIC UNITS ARE PROVIDED ON PRODUCTS THROUGHOUT THE CATALOG. UNLESS STATED OTHERWISE, METRIC UNITS SHOULD BE USED FOR REFERENCE PURPOSES ONLY. PRODUCTS SUBJECT TO CHANGE WITHOUT NOTICE. ALL SALES OF OUR PRODUCT ARE SUBJECT TO A LIMITED WARRANTY AND PURCHASERS ARE SOLELY RESPONSIBLE FOR INSTALLATION AND USE OF OUR PRODUCTS AND DETERMINING WHETHER A PRODUCT IS SUITED FOR ANY SPECIFIC NEEDS. PLEASE CONSULT A FULL COPY OF TERMS AND CONDITIONS FOR SALE FOR FURTHER DETAILS.

PRODUCT APPLICATIONS

APPLICATIONS	TRIPLE WALL	DUAL WALL						SINGLE WALL	
	POLYPROPYLENE (PP)	PP	HIGH DENSITY POLYETHYLENE PIPE (HDPE)				HDPE		
	SANITITE® HP	HP STORM	N-12® LOW HEAD	N-12 WT	N-12 ST	N-12 PLAIN END	MEGA GREEN	HIGHWAY	HEAVY DUTY
CONSTRUCTION PRODUCTS									
STORM SEWER		•		•	•	•	•		
RETENTION/DETENTION		•		•	•	•	•	•	
CULVERTS/CROSS DRAINS		•		•	•	•	•	•	•
SLOPE/EDGE DRAINS		•		•	•	•	•	•	•
MINING/FORESTRY/INDUSTRIAL		•		•	•	•	•		
POST TENSIONING									
RESIDENTIAL PRODUCTS									
FOUNDATIONS/EDGE DRAINS				•	•	•	•		•
DOWNSPOUTS/ROOF DRAINAGE				•	•	•	•		•
CULVERTS		•		•	•	•	•	•	•
SUB DRAINAGE									•
ON-SITE WASTE MANAGEMENT									
RECREATION PRODUCTS									
PATHS/WALKWAYS/EDGE DRAINS				•	•	•	•		•
SPORTS PLAYING FIELDS		•		•	•	•	•	•	•
CULVERTS				•	•	•	•	•	•
PARKING LOT DRAINAGE		•		•	•	•	•	•	•
GOLF COURSE DRAINAGE					•	•	•	•	•
LANDSCAPE/SUB DRAINAGE								•	•
AGRICULTURE PRODUCTS									
FIELD DRAINAGE									•
GRAIN AERATION					•	•	•		•
LAND RECLAMATION				•	•	•	•		•
WATERWAYS				•	•	•	•	•	•
TERRACING				•	•	•	•	•	•
DITCH ENCLOSURES		•	•	•	•	•	•	•	•
SANITARY SEWER/ INDUSTRIAL PRODUCTS									
SANITARY SEWER TRUNK LINES	•								
INDUSTRIAL WASTE	•								
IRRIGATION TRANSMISSION LINES			•						

SUGGESTED PRODUCTS AND APPLICATIONS ARE PROVIDED FOR GENERAL GUIDANCE ONLY.
CONTACT A SALES REPRESENTATIVE TO DISCUSS THE PRODUCTS ACCEPTABLE FOR SPECIFIC APPLICATIONS.

PRODUCT APPLICATIONS

APPLICATIONS	SINGLE WALL							
	HIGH DENSITY POLYETHYLENE PIPE (HDPE)							
	CO-EX	CHANNEL MUCK	CHANNEL FLOW	GRAVEL-LESS	SMOOTHWALL/TRIPLE WALL	TURF FLOW	POST TENSIONING DUCT	BEND-A-DRAIN™
CONSTRUCTION PRODUCTS								
STORM SEWER								
RETENTION/DETENTION								
CULVERTS/CROSS DRAINS								
SLOPE/EDGE DRAINS								
MINING/FORESTRY/INDUSTRIAL								
POST TENSIONING							•	
RESIDENTIAL PRODUCTS								
FOUNDATIONS/EDGE DRAINS					•	•		
DOWNSPOUTS/ROOF DRAINAGE					•			•
CULVERTS								
SUB DRAINAGE					•	•		
ON-SITE WASTE MANAGEMENT			•	•	•			
RECREATION PRODUCTS								
PATHS/WALKWAYS/EDGE DRAINS					•	•		
SPORTS PLAYING FIELDS					•	•		
CULVERTS								
PARKING LOT DRAINAGE								
GOLF COURSE DRAINAGE					•	•		
LANDSCAPE/SUB DRAINAGE					•	•		•
AGRICULTURE PRODUCTS								
FIELD DRAINAGE	•	•						
GRAIN AERATION								
LAND RECLAMATION	•	•						
WATERWAYS								
TERRACING								

SANITARY PIPE

SANITITE® HP

APPLICATIONS: A high-performance polypropylene pipe for use in gravity flow, wastewater conveyance, and high performance storm drain systems. Typically used in trunk/interceptor sanitary sewers to service treatment plant flow.

CHARACTERISTICS

PRODUCT	DESCRIPTION	DIAMETER	CONNECTIONS	SPECIFICATIONS/ PERFORMANCE
SANITITE HP	Annular corrugations with smooth interior wall. 30"-60" Triple Wall has smooth exterior surface. Pipe is bell-and-spigot with the bell being reinforced with a polymer wrap and the spigot having two gaskets.	12"-30" (300-750 mm) Dual Wall	Bell-and-spigot with two rubber gaskets meeting ASTM D3212.	12"-60" (300-1500 mm) meets ASTM F2764. 12"-60" (300-1500 mm) joints meet the requirements of ASTM F2764.
		30"-60" (750-1500 mm) Triplewall		

SANITITE HP

DIAMETER	LENGTH	STYLE	SANITITE HP
12" (300 mm)	13' (4.0m)	Dual wall	1230 0013 IBPP
	20' (6.1m)	Dual wall	1230 0020 IBPP
15" (375 mm)	13' (4.0m)	Dual wall	1530 0013 IBPP
	20' (6.1m)	Dual wall	1530 0020 IBPP
18" (450 mm)	13' (4.0m)	Dual wall	1830 0013 IBPP
	20' (6.1m)	Dual wall	1830 0020 IBPP
21"* (525 mm)	13' (4.0m)	Dual wall	2130 0013 IBPP
	20' (6.1m)	Dual wall	2130 0020 IBPP
24" (600 mm)	13' (4.0m)	Dual wall	2430 0013 IBPP
	20' (6.1m)	Dual wall	2430 0020 IBPP
30" (750 mm)	13' (4.0m)	Dual wall	3030 0013 IBPP
	20' (6.1m)	Dual wall	3030 0020 IBPP
30" (750 mm)	13' (4.0m)	Triple wall	3030 0013 IBHP
	20' (6.1m)	Triple wall	3030 0020 IBHP
36" (900 mm)	13' (4.0m)	Triple wall	3630 0013 IBHP
	20' (6.1m)	Triple wall	3630 0020 IBHP
42" (1050 mm)	13' (4.0m)	Triple wall	4230 0013 IBHP
	20' (6.1m)	Triple wall	4230 0020 IBHP
48" (1200 mm)	13' (4.0m)	Triple wall	4830 0013 IBHP
	20' (6.1m)	Triple wall	4830 0020 IBHP
60" (1500 mm)	16' (5.0m)	Triple wall	6030 0016 IBHP
	20' (6.1m)	Triple wall	6030 0020 IBHP

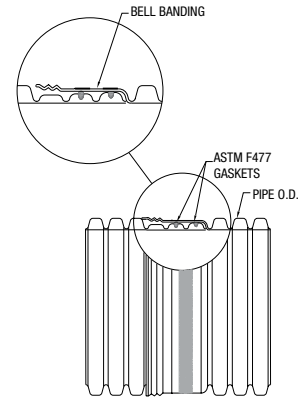

**SANITITE HP
DUAL WALL**

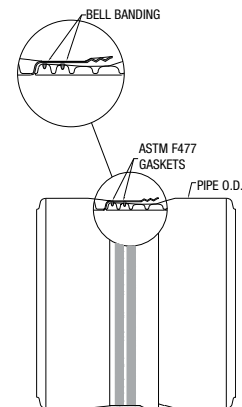

**SANITITE HP
TRIPLEWALL**

*LIMITED GEOGRAPHIC AVAILABILITY. PLEASE CHECK WITH SALES REPRESENTATIVE FOR AVAILABILITY.

STORM SEWER PIPE

HP STORM

APPLICATIONS: HP Storm is a high-performance polypropylene pipe for gravity-flow storm drainage applications.

CHARACTERISTICS

PRODUCT	DESCRIPTION	DIAMETER	CONNECTIONS	SPECIFICATIONS/ PERFORMANCE
HP STORM	Annular corrugations with smooth interior surface. Pipe is bell-and-spigot with the bell being reinforced with a polymer wrap.	12"-60" (300-1500 mm) Dual Wall	Bell-and-spigot with a rubber gasket meeting ASTM F477.	12"-60" (300-1500 mm) meets or exceeds ASTM F2881 and AASHTO M330.

HP STORM

DIAMETER	LENGTH	PRODUCT CODE
12" (300 mm)	20' (6.1 m)	1265 0020 IBPL
15" (375 mm)	20' (6.1 m)	1565 0020 IBPL
18" (450 mm)	20' (6.1 m)	1865 0020 IBPL
24" (600 mm)	20' (6.1 m)	2465 0020 IBPL
30" (750 mm)	20' (6.1 m)	3065 0020 IBPL
36" (900 mm)	20' (6.1 m)	3665 0020 IBPL
42" (1050 mm)	20' (6.1 m)	4265 0020 IBPL
48" (1200 mm)	20' (6.1 m)	4865 0020 IBPL
60" (1500 mm)	20' (6.1 m)	6065 0020 IBPL

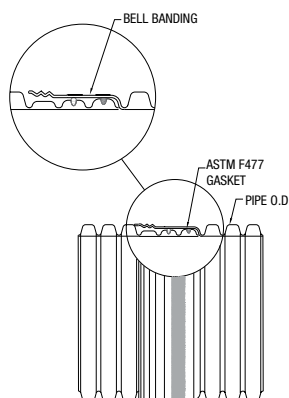

**HP STORM
DUAL WALL**

DUAL WALL HDPE PIPE

**N-12® LOW-HEAD, N-12 WT IB, N-12 ST IB,
N-12 PLAIN END, MEGA GREEN® WT IB,
MEGA GREEN ST IB, MEGA GREEN PLAIN END**

CHARACTERISTICS

PRODUCT	DESCRIPTION	DIAMETER	CONNECTION	SPECIFICATIONS/ PERFORMANCE
N-12 LOW-HEAD IRRIGATION	Annular corrugations with HDB rated smooth interior liner. Pipe is bell-and-spigot with the bell being reinforced with a polymer wrap and the spigot having two gaskets.	24" - 60" * (600-1500mm)	Bell-and-spigot with 2 rubber gaskets meeting ASTM F477.	24" - 60" (600-1500mm) meets ASTM F2306. Joints meet the requirements of ASTM D3212.
N-12 WT IB	Annular corrugations with smooth interior liner. Pipe is bell-and-spigot with a gasket.	4" - 60" (100-1500mm)	Bell-and-spigot with rubber gasket meeting ASTM F477.	4" - 10" (100-250mm) meets AASHTO M252, Type S. ** 12" - 60" (300-1500mm) meets ASTM F2306 and AASHTO M294, Type S. Joints meet the requirement of ASTM D3212.**
N-12 ST IB	Annular corrugations with smooth interior.	4" - 60" (100-1500mm)	12" - 60" bell-and-spigot with rubber gasket meeting ASTM F477.	4" - 10" (100-250mm) meets AASHTO M252, Type S. ** 12" - 60" (300-1500mm) meets ASTM F2306 and AASHTO M294, Type S.**
N-12 PLAIN END	Annular corrugations with smooth interior.	4" - 60" (100-1500mm)	External snap or split band couplers depending on diameter.	4" - 10" (100-250mm) meets AASHTO M252, Type S.** 12" - 60" (300-1500mm) meets AASHTO M294, Type S.**
MEGA GREEN WT IB	Annular corrugations with smooth interior liner. Pipe is bell-and-spigot with a gasket.	4" - 60" (100-1500mm)	Bell-and-spigot with rubber gasket meeting ASTM F477.	4" - 60" (100-1500mm) meets ASTM F2648. Joints meet the requirement of ASTM D3212.
MEGA GREEN ST IB	Annular corrugations with smooth interior.	4" - 60" (100-1500mm)	12" - 60" bell-and-spigot with rubber gasket meeting ASTM F477.	4" - 60" (100-1500mm) meets ASTM F2648.
MEGA GREEN PLAIN END	Annular corrugations with smooth interior.	4" - 60" * (100-1500mm)	External snap or split band couplers depending on diameter.	4" - 60" (100-1500mm) meets ASTM F2648.

*Not available in 54"

**Also available manufactured from Engineered Compound meeting ASTM F2648

DUAL WALL HDPE PIPE

N-12[®] LOW-HEAD

N-12 LOW-HEAD APPLICATIONS: ADS Low-Head Pipe is made of polyethylene and is utilized for ditch enclosures and water transmission.

24" - 60" DUAL WALL PIPE OFFERINGS

INSIDE DIAMETER	STANDARD LENGTHS	N-12 LOW-HEAD IRRIGATION*
24" (600mm)	20' (6.1m)	24600020IB
30" (750mm)	20' (6.1m)	30600020IB
36" (900mm)	20' (6.1m)	36600020IB
42" (1050mm)	20' (6.1m)	42600020IB
48" (1200mm)	20' (6.1m)	48600020IB
60" (1500mm)	20' (6.1m)	60600020IB

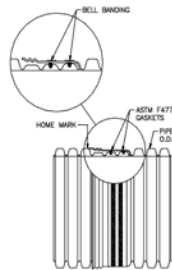

24"-60" (600-1500mm)
N-12 LOW-HEAD IRRIGATION

*LIMITED GEOGRAPHIC AVAILABILITY

DUAL WALL PIPE

STORM DRAINAGE

N-12 PLAIN END, N-12 ST & N-12 WT per AASHTO

4" - 10" DUAL WALL PIPE OFFERINGS

DIAMETER	LENGTHS	STYLE	N-12 PLAIN END	N-12 ST*	N-12 WT*
4" (100mm)	10' (3.0m)	solid	04150010	04150010IB	04650010IB
		perf	04110010	04110010IB	
	20' (6.1m)	solid	04150020	04150020IB	04650020IB
		perf	04110020	04110020IB	
		sock	04230020	04230020IB	
	6" (150mm)	10' (3.0m)	solid	06150010	06150010IB
perf			06110010	06110010IB	
20' (6.1m)		solid	06150020	06150020IB	06650020IB
		perf	06110020	06110020IB	
		sock	06230020	06230020IB	
8" (200mm)		10' (3.0m)	solid	08150010	08150010IB
	perf		08110010	08110010IB	
	20' (6.1m)	solid	08150020	08150020IB	08650020IB
		perf	08110020	08110020IB	
		sock	08230020	08230020IB	
	10" (250mm)	10' (3.0m)	solid	10150010	10150010IB
perf			10110010	10110010IB	
20' (6.1m)		solid	10150020	10150020IB	10650020IB
		perf	10110020	10110020IB	
		sock	10230020	10230020IB	

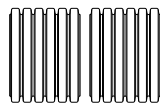

4"-10" (100-250mm)
N-12 PLAIN END

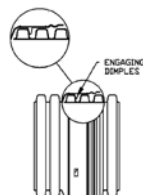

4"-10" (100-250mm)
N-12 ST
BELL-AND-SPIGOT

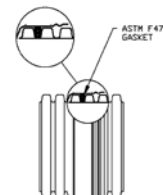

4"-10" (100-250mm)
N-12 WT
BELL-AND-SPIGOT

DUAL WALL PIPE

STORM DRAINAGE

N-12 PLAIN END, N-12 ST IB & N-12 WT IB per AASHTO

12" - 60" DUAL WALL PIPE OFFERINGS

DIAMETER	LENGTHS	STYLE	N-12 PLAIN END	N-12 ST IB	N-12 WT IB
12" (300mm)	13' (4.0m)	solid		12850013IB	12650013IB
	20' (6.1m)	solid	12950020	12850020IB	12650020IB
		perf	12910020	12810020IB	
		sock	12930020	12830020IB	
15" (375mm)	13' (4.0m)	solid		15850013IB	15650013IB
	20' (6.1m)	solid	15950020	15850020IB	15650020IB
		perf	15910020	15810020IB	
		sock	15930020	15830020IB	
18" (450mm)	13' (4.0m)	solid		18850013IB	18650013IB
	20' (6.1m)	solid	18950020	18850020IB	18650020IB
		perf	18910020	18810020IB	
		sock	18930020	18830020IB	
24" (600mm)	13' (4.0m)	solid		24850013IB	24650013IB
	20' (6.1m)	solid	24950020	24850020IB	24650020IB
		perf	24910020	24810020IB	
		sock	24930020	24830020IB	
30" (750mm)	13' (4.0m)	solid		30850013IB	30650013IB
	20' (6.1m)	solid	30950020	30850020IB	30650020IB
		perf	30910020	30810020IB	
		sock	30930020	30830020IB	
36" (900mm)	13' (4.0m)	solid		36850013IB	36650013IB
	20' (6.1m)	solid	36950020	36850020IB	36650020IB
		perf	36910020	36810020IB	
		sock		36830020IB	
42" (1050mm)	13' (4.0m)	solid		42850013IB	42650013IB
	20' (6.1m)	solid	42950020	42850020IB	42650020IB
		perf	42910020	42810020IB	
		sock		42830020IB	
48" (1200mm)	13' (4.0m)	solid		48850013IB	48650013IB
	20' (6.1m)	solid	48950020	48850020IB	48650020IB
		perf	48910020	48810020IB	
		sock		48830020IB	
54"* (1350mm)	12.5' (3.8m)	solid		54850013IBA	54650013IBHA
	20.5' (6.2m)	solid		54850021IBA	54650021IBHA
60" (1500mm)	13' (4.0m)	solid		60850013IB	60650013IB
	20' (6.1m)	solid	60950020	60850020IB	60650020IB
		perf	60910020	60810020IB	
		sock		60830020IB	

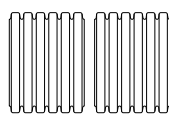

12"-60" (300-1500mm)
N-12 PLAIN END

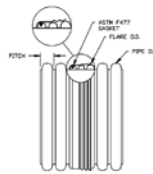

12"-60" (300-1500mm)
N-12 ST IB

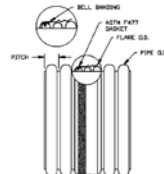

12"-60" (300-1500mm)
N-12 WT IB

*LIMITED GEOGRAPHIC AVAILABILITY

DUAL WALL PIPE

STORM DRAINAGE

N-12[®] PLAIN END, N-12 ST & N-12 WT per ASTM F2648

4" - 10" DUAL WALL PIPE OFFERINGS

DIAMETER	LENGTHS	STYLE	N-12 PLAIN END	N-12 ST*	N-12 WT*
4" (100mm)	10' (3.0m)	solid	04150010DW	04150010BDW	04650010BDW
		perf	04110010DW	04110010BDW	
	20' (6.1m)	solid	04150020DW	04150020BDW	04650020BDW
		perf	04110020DW	04110020BDW	
		sock	04230020DW	04230020BDW	
	6" (150mm)	10' (3.0m)	solid	06150010DW	06150010BDW
perf			06110010DW	06110010BDW	
20' (6.1m)		solid	06150020DW	06150020BDW	06650020BDW
		perf	06110020DW	06110020BDW	
		sock	06230020DW	06230020BDW	
8" (200mm)		10' (3.0m)	solid	08150010DW	08150010BDW
	perf		08110010DW	08110010BDW	
	20' (6.1m)	solid	08150020DW	08150020BDW	08650020BDW
		perf	08110020DW	08110020BDW	
		sock	08230020DW	08230020BDW	
	10" (250mm)	10' (3.0m)	solid	10150010DW	10150010BDW
perf			10110010DW	10110010BDW	
20' (6.1m)		solid	10150020DW	10150020BDW	10650020BDW
		perf	10110020DW	10110020BDW	
		sock	10230020DW	10230020BDW	

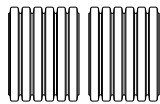

4"-10" (100-250mm)
N-12 PLAIN END

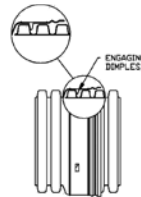

4"-10" (100-250mm)
**N-12 ST
BELL-AND-SPIGOT**

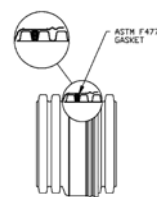

4"-10" (100-250mm)
**N-12 WT
BELL-AND-SPIGOT**

DUAL WALL PIPE

STORM DRAINAGE

N-12[®] PLAIN END, N-12[®] ST IB & N-12[®] WT IB

per ASTM F2648

12" - 60" DUAL WALL PIPE OFFERINGS

DIAMETER	LENGTHS	STYLE	N-12 PLAIN END	N-12 ST IB	N-12 WT IB
12" (300mm)	13' (4.0m)	solid		12850013DW	12650013DW
	20' (6.1m)	solid	12950020DW	12850020DW	12650020DW
		perf	12910020DW	12810020DW	
15" (375mm)	13' (4.0m)	solid		15850013DW	15650013DW
	20' (6.1m)	solid	15950020DW	15850020DW	15650020DW
		perf	15910020DW	15810020DW	
18" (450mm)	13' (4.0m)	solid		18850013DW	18650013DW
	20' (6.1m)	solid	18950020DW	18850020DW	18650020DW
		perf	18910020DW	18810020DW	
24" (600mm)	13' (4.0m)	solid		24850013DW	24650013DW
	20' (6.1m)	solid	24950020DW	24850020DW	24650020DW
		perf	24910020DW	24810020DW	
30" (750mm)	13' (4.0m)	solid		30850013DW	30650013DW
	20' (6.1m)	solid	30950020DW	30850020DW	30650020DW
		perf	30910020DW	30810020DW	
36" (900mm)	13' (4.0m)	solid		36850013DW	36650013DW
	20' (6.1m)	solid	36950020DW	36850020DW	36650020DW
		perf	36910020DW	36810020DW	
42" (1050mm)	13' (4.0m)	solid		42850013DW	42650013DW
	20' (6.1m)	solid	42950020DW	42850020DW	42650020DW
		perf	42910020DW	42810020DW	
48" (1200mm)	13' (4.0m)	solid		48850013DW	48650013DW
	20' (6.1m)	solid	48950020DW	48850020DW	48650020DW
		perf	48910020DW	48810020DW	
60" (1500mm)	13' (4.0m)	solid		60850013DW	60650013DW
	20' (6.1m)	solid	60950020DW	60850020DW	60650020DW
		perf	60910020DW	60810020DW	
		sock		60830020DW	

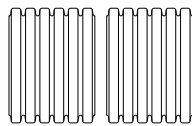

12"-60" (300-1500mm)
N-12 PLAIN END

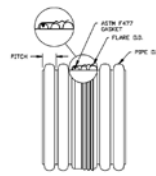

12"-60" (300-1500mm)
N-12 ST IB

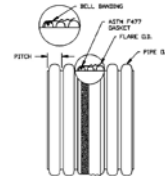

12"-60" (300-1500mm)
N-12 WT IB

DUAL WALL PIPE

STORM DRAINAGE

MEGA GREEN

4" - 10" DUAL WALL PIPE OFFERINGS

DIAMETER	LENGTHS	STYLE	MEGA GREEN PLAIN END	MEGA GREEN ST*	MEGA GREEN WT*
4" (100mm)	10' (3.0m)	solid	04150010DW	04150010IBDW	04650010IBDW
		perf	04110010DW	04110010IBDW	
	20' (6.1m)	solid	04150020DW	04150020IBDW	04650020IBDW
		perf	04110020DW	04110020IBDW	
		sock	04230020DW	04230020IBDW	
6" (150mm)	10' (3.0m)	solid	06150010DW	06150010IBDW	06650010IBDW
		perf	06110010DW	06110010IBDW	
	20' (6.1m)	solid	06150020DW	06150020IBDW	06650020IBDW
		perf	06110020DW	06110020IBDW	
		sock	06230020DW	06230020IBDW	
8" (200mm)	10' (3.0m)	solid	08150010DW	08150010IBDW	08650010IBDW
		perf	08110010DW	08110010IBDW	
	20' (6.1m)	solid	08150020DW	08150020IBDW	08650020IBDW
		perf	08110020DW	08110020IBDW	
		sock	08230020DW	08230020IBDW	
10" (250mm)	10' (3.0m)	solid	10150010DW	10150010IBDW	10650010IBDW
		perf	10110010DW	10110010IBDW	
	20' (6.1m)	solid	10150020DW	10150020IBDW	10650020IBDW
		perf	10110020DW	10110020IBDW	
		sock	10230020DW	10230020IBDW	

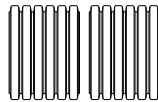

4"-10" (100-250mm)
**MEGA GREEN
PLAIN END**

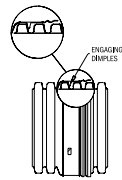

4"-10" (100-250mm)
**MEGA GREEN ST
BELL-AND-SPIGOT**

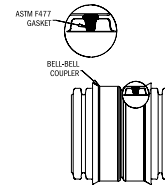

4"-10" (100-250mm)
**MEGA GREEN WT
BELL-AND-SPIGOT**

*LIMITED GEOGRAPHIC AVAILABILITY

DUAL WALL PIPE

STORM DRAINAGE

MEGA GREEN

**12"- 60" DUAL WALL
PIPE OFFERINGS**

DIAMETER	LENGTHS	STYLE	MEGA GREEN PLAIN END	MEGA GREEN ST IB	MEGA GREEN WT IB
12" (300mm)	13' (4.0m)	solid		12850013DW	12650013IBDW
		solid	12950020DW	12850020DW	12650020IBDW
	20' (6.1m)	perf	12910020DW	12810020DW	
		sock	12930020DW	12830020DW	
15" (375mm)	13' (4.0m)	solid		15850013DW	15650013IBDW
		solid	15950020DW	15850020DW	15650020IBDW
	20' (6.1m)	perf	15910020DW	15810020DW	
		sock	15930020DW	15830020DW	
18" (450mm)	13' (4.0m)	solid		18850013DW	18650013IBDW
		solid	18950020DW	18850020DW	18650020IBDW
	20' (6.1m)	perf	18910020DW	18810020DW	
		sock	18930020DW	18830020DW	
24" (600mm)	13' (4.0m)	solid		24850013DW	24650013IBDW
		solid	24950020DW	24850020DW	24650020IBDW
	20' (6.1m)	perf	24910020DW	24810020DW	
		sock	24930020DW	24830020DW	
30" (750mm)	13' (4.0m)	solid		30850013DW	30650013IBDW
		solid	30950020DW	30850020DW	30650020IBDW
	20' (6.1m)	perf	30910020DW	30810020DW	
		sock	30930020DW	30830020DW	
36" (900mm)	13' (4.0m)	solid		36850013DW	36650013DW
		solid	36950020DW	36850020DW	36650020DW
	20' (6.1m)	perf	36910020DW	36810020DW	
		sock		36830020DW	
42" (1050mm)	13' (4.0m)	solid		42850013DW	42650013DW
		solid	42950020DW	42850020DW	42650020DW
	20' (6.1m)	perf	42910020DW	42810020DW	
		sock		42830020DW	
48" (1200mm)	13' (4.0m)	solid		48850013DW	48650013DW
		solid	48950020DW	48850020DW	48650020DW
	20' (6.1m)	perf	48910020DW	48810020DW	
		sock		48830020DW	
60" (1500mm)	13' (4.0m)	solid		60850013DW	60650013DW
		solid	60950020DW	60850020DW	60650020DW
	20' (6.1m)	perf	60910020DW	60810020DW	
		sock		60830020DW	

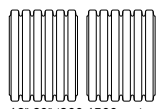

12"-60" (300-1500mm)

**MEGA GREEN
PLAIN END**

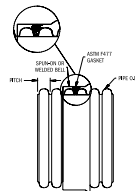

12"-60" (300-1500mm)

**MEGA GREEN
ST IB**

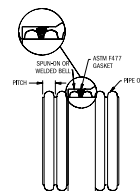

12"-60" (300-1500mm)

**MEGA GREEN
WT IB**

SINGLE WALL PIPE

CHARACTERISTICS

PRODUCT	DESCRIPTION	DIAMETER RANGE	LENGTH	CONNECTION	SPECIFICATIONS/ PERFORMANCE
HIGHWAY PIPE	Annular corrugated single wall	3"-24" (75-600 mm)	100'-3,200' (30-960 m) coil for 3"-6" (75-150 mm) diameter pipe. 20' (6 m) for 8"-24" (200-600 mm) diameter pipe.	Internal, external snap or split band couplers	3"-10" (75-250 mm): AASHTO M252, Type C 12"-24" (300-600 mm): AASHTO M294, Type C
HEAVY DUTY PIPE	Annular corrugated single wall	3"-24" (75-600 mm)	100'-5,500' (30-1676 m) coils, depending on pipe diameter. 10'-20' (3-6 m) sticks.	Internal, external snap or split band couplers	3"-24" (75-600 mm): ASTM F667
CO-EX	Annular corrugated single wall with white exterior and black interior	4"-6" (100-150 mm)	100'-3,200' (30-960 m) depending on the diameter	Internal or external snap couplers	ASTM F667
CHANNEL MUCK PIPE	Annular corrugated single wall with 3/4" holes	4" (100 mm)	100'-3,200' (30-960 m) depending on the diameter	Internal or external snap couplers	ASTM F667
CHANNEL FLOW PIPE	Annular corrugated single wall with 3/4" holes	4" (100 mm)	10'-250' (3-75 m)	Internal or external snap couplers	ASTM F667
GRAVEL-LESS PIPE	Annular corrugated single wall wrapped in geotextile fabric with 5/8" holes	8" (200 mm) 10" (250 mm)	10' (3 m) 20' (6 m)	Internal snap or split band coupler	ASTM F667
SMOOTHWALL/ TRIPLEWALL PIPE	Smooth white exterior and smooth black interior	3" (75 mm) 4" (100 mm) 6" (150 mm)	10' (3 m)	Bell-and-spigot	ASTM F810
TURF FLOW PIPE	Spiral corrugated single wall	2" (50 mm)	Rolls up to 500' (150 m)	External couplers	Local/ Manufacturer's recommendations
POST TENSIONING PIPE	Spiral corrugated single wall	2" (50 mm)	500' (150 m)	External couplers	Local/ Manufacturer's recommendations
POLYFLEX	Smooth exterior and interior polyethylene pressure pipe	1/2" (13 mm) 3/4" (19 mm) 1" (25 mm) 1 1/4" (32 mm) 1 1/2" (38 mm) 2" (50 mm)	100'-500' (30-152 m)	Internal and external couplers	ASTM D2239 ASTM D2737
GRAIN-AIRE GRAIN AERATION PIPE	Annular corrugated single and dual wall	12" (300 mm) 15" (375 mm) 18" (450 mm)** 24" (600 mm)**	20' (6 m)	Split band coupler	Local/ Manufacturer's recommendations
BEND-A-DRAIN	Bendable, expandable single wall pipe	4" (100 mm)	12' (3.6 m) 25' (7.6 m)	External coupler	Local/ Manufacturer's recommendations

* LIMITED GEOGRAPHIC AVAILABILITY

**DUAL WALL PIPE

SINGLE WALL PIPE

HIGHWAY

4" - 24" HIGHWAY SINGLE WALL

INSIDE DIAMETER	OUTSIDE DIAMETER	STANDARD LENGTHS	STYLE	PRODUCT CODE
4" (100mm)	4.6" (117mm)	100' (30.5m)	Plain	04400100
		250' (76.2m)	Plain	04400250
			Perf	04410250
		250' (76.2m)	Perf/wrap	04430250
3200' (975.4m)	04433200			
6" (150mm)	7.0" (178mm)	100' (30.5m)	Plain	06400100
		1500' (457.2m)		06401500
		100' (30.5m)	Perf	06410100
		1500' (457.2m)		06411500
		100' (30.5m)	Perf/wrap	06430100
		1500' (457.2m)		06431500
8" (200mm)	9.5" (241mm)	20' (6.1m)	Plain	08400020
			Perf	08410020
			Perf/wrap	08430020
10" (250mm)	12.0" (300mm)	20' (6.1m)	Plain	10400020
			Perf	10410020
			Perf/wrap	10430020
12" (300mm)	14.2" (361mm)	20' (6.1m)	Plain	12400020
			Perf	12410020
			Perf/wrap	12430020
15" (375mm)	17.7" (450mm)	20' (6.1m)	Plain	15400020
			Perf	15410020
			Perf/wrap	15430020
18" (450mm)	21.5" (546mm)	20' (6.1m)	Plain	18400020
			Perf	18410020
			Perf/wrap	18430020
24" (600mm)	28.4" (721mm)	20' (6.1m)	Plain	24400020
			Perf	24410020
			Perf/wrap	24430020

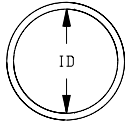
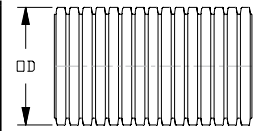

HIGHWAY PIPE

SINGLE WALL PIPE

HEAVY DUTY

3" - 10" HEAVY DUTY SINGLE WALL

INSIDE DIAMETER	STANDARD LENGTHS	STYLE	REGULAR	HEAVY DUTY
3" (75mm)	10' (3.0m)	Solid	03510010	
	100' (30.5m)		03510100	03800100
	250' (76.2m)		03510250	03800250
	10' (3.0m)	Perf	03010010	
	100' (30.5m)		03010100	03810100
	250' (76.2m)		03010250	03810250
	5500' (1676.4m)			03815500
	100' (30.5m)	Perf/wrap	03730100BS	03830100BS
250' (76.2m)	03730250BS		03830250BS	
4" (100mm)	10' (3.0m)	Solid	04510010	
	100' (30.5m)		04510100	04800100
	250' (76.2m)		04510250	04800250
	3200' (975.4m)			04803200
	10' (3.0m)	Perf	04010010	
	100' (30.5m)		04010100	04810100
	250' (76.2m)		04010250	04810250
	3200' (975.4m)			04813200
	100' (30.5m)	Perf/wrap	04730100BS	04830100BS
	250' (76.2m)		04730250BS	04830250BS
3200' (975.4m)			048303200BS	
5" (125mm)	180' (54.9m)	Solid	05510180	05800180
	180' (54.9m)	Perf	05010180	05810180
	180' (54.9m)	Perf/wrap	05730180BS	05830180BS
	2000' (609.6m)	Perf		05812000
	2000' (609.6m)	Perf/wrap		05832000BS
6" (150mm)	10' (3.0m)	Solid	06510010	
	20' (6.1m)		06510020	06800020
	100' (30.5m)		06510100	06800100
	1500' (457.2m)			06801500
	10' (3.0m)	Perf	06010010	
	20' (6.1m)		06010020	06810020
	100' (30.5m)		06010100	06810100
	1500' (457.2m)			06811500
	100' (30.5m)	Perf/wrap	06730100BS	06830100BS
	1500' (457.2m)			06831500BS
8" (200mm)	20' (6.1m)	Solid	08510020	08800020
	820' (249.9m)			08800820
	20' (6.1m)	Perf	08010020	08810020
	820' (249.9m)			08810820
	20' (6.1m)	Perf/wrap	08730020	08830020
	820' (249.9m)			08830820
10" (250mm)	20' (6.1m)	Solid	10510020	10800020
	490' (149.4m)			10800520
	20' (6.1m)	Perf	10010020	10810020
	520' (158.5m)			10810520
	20' (6.1m)	Perf/wrap	10730020	10830020
520' (158.5m)			10830520	

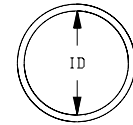
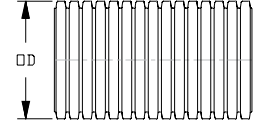

HEAVY DUTY PIPE

SINGLE WALL PIPE

HEAVY DUTY, CO-EX

12" - 24" HEAVY DUTY SINGLE WALL

INSIDE DIAMETER	OUTSIDE DIAMETER	STANDARD LENGTHS	STYLE	PRODUCT CODE
12" (300mm)	14.2" (361mm)	295' (90.0m)	Plain	12510295
			Perf	12010295
			Perf/wrap	12730295
12" (300mm)	14.2" (361mm)	20' (6.1m)	Plain	12510020
			Perf	12010020
15" (375mm)	17.7" (450mm)	20' (6.1m)	Plain	15510020
			Perf	15010020
18" (450mm)	21.5" (546mm)	20' (6.1m)	Plain	18510020
			Perf	18010020
24" (600mm)	28.4" (721mm)	20' (6.1m)	Plain	24510020
			Perf	24010020

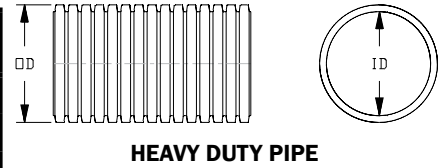

4"-6" CO-EX SINGLE WALL

INSIDE DIAMETER	OUTSIDE DIAMETER	STANDARD LENGTHS	STYLE	PRODUCT CODE
4" (100mm)	4.6" (117mm)	100' (30.5m)	Plain	04070100
		250' (76.2m)		04070250
		100' (30.5m)	Perf	04080100
		250' (76.2m)		04080250
		3200' (975.4m)		04083200
6" (150mm)	6.?????"	100' (30.5m)	Plain	06070100
		1500' (457.2m)		06071500
		100' (30.5m)	Perf	06080100
		1500' (457.2m)		06081500

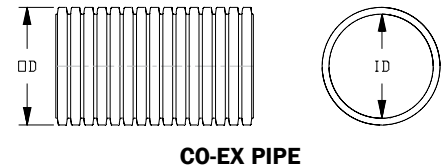

SINGLE WALL PIPE

CHANNEL MUCK, CHANNEL-FLOW[®], GRAVELLESS

4" CHANNEL MUCK SINGLE WALL

INSIDE DIAMETER	OUTSIDE DIAMETER	STANDARD LENGTHS	STYLE	PRODUCT CODE
4" (100mm)	4.7" (119mm)	100' (30.5m)	Perf 3-hole, 360°	04060100
		250' (76.2m)		04060250
		3200' (975.4m)		04063200
		250' (76.2m)	Perf/Wrap	04770250
		2900' (883.9m)		04772900

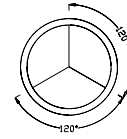
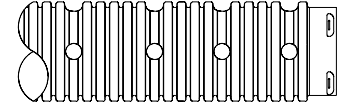

CHANNEL MUCK PIPE

4" CHANNEL-FLOW SINGLE WALL

INSIDE DIAMETER	STANDARD LENGTHS	STYLE	PRODUCT CODE
4" (100mm)	10' (3.0m)	Perf 3-hole, 120°	04020010
	100' (30.5m)		04020100
	250' (76.2m)		04020250

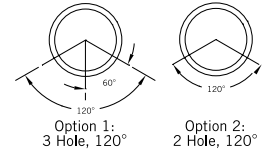
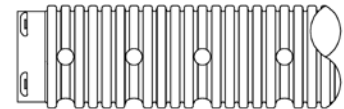

CHANNEL-FLOW PIPE

8", 10" SB2

DIAMETER	LENGTHS	STYLE	PRODUCT CODE
8" (200mm)	10' (3.0m)	perf/cerex	08710010
		perf/cerex with coupler	08710010WC
	20' (6.1m)	perf/cerex	08710020
		perf/cerex with coupler	08710020WC
		perf/cerex with coupler	08710020WCH
		perf/sock	08710020WS
10" (250mm)	10' (3.0m)	perf/cerex	10710010
		perf/cerex	10710010WC
		perf/sock with coupler	10710010WSH
	20' (6.1m)	perf/cerex	10710020
		perf/cerex with coupler	10710020WC
		perf/cerex with coupler	10710020WCH
		perf/sock	10710020WS
		perf/sock bundle wrap	10710020WSBW
		perf/sock with coupler	10710020WSH

SYNTHETIC FILTER WRAP

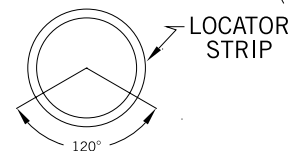
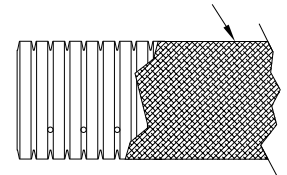

SB2[®]

SINGLE WALL PIPE

TURF FLOW[®], POST-TENSIONING DUCT, GRAIN-AIRE[®]

2" TURF FLOW SINGLE WALL

INSIDE DIAMETER	OUTSIDE DIAMETER	STANDARD LENGTHS	STYLE	PRODUCT CODE
2" (50mm)	2.4" (61mm)	25' (7.6m)	Plain	02510025
		100' (30.5m)	Plain	02510100
			Wide Slot	02010100
		118' (36.0m)	Wide Slot	02010118
			Wide Slot with Wrap	02730118
		500' (152.4m)	Narrow Slot	02510500NS
		50' (15.2m)	Wide Slot	02010050
		300' (91.4m)	Wide Slot	02010300
50' (15.2m)	Plain	02510050		

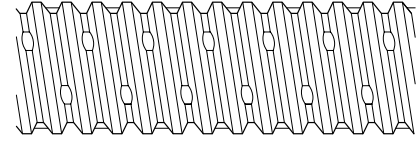

TURF FLOW PIPE

POST-TENSIONING DUCT

DIAMETER	STANDARD LENGTH	PRODUCT CODE
2" (50mm)	500' (152.4m)	02510500PT

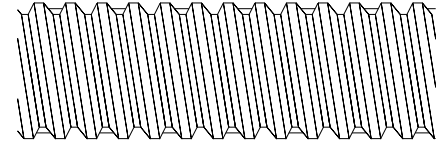

POST-TENSIONING DUCT

GRAIN-AIRE PIPE WITH SCREEN SLEEVE

	DESCRIPTION	PRODUCT CODE
Single Wall Pipe	15" (375mm) Grain-Aire Pipe 20' (6.1m) L	15840020SW
	18" (450mm) Grain-Aire Pipe 20' (6.1m) L	18840020SW
Dual Wall Pipe	12" (300mm) Grain-Aire Pipe 20' (6.1m) L	12840020
	15" (375mm) Grain-Aire Pipe 20' (6.1m) L	15840020
	18" (450mm) Grain-Aire Pipe 20' (6.1m) L	18840020
	24" (600mm) Grain-Aire Pipe 20' (6.1m) L	24840020
	30" (750mm) Grain-Aire Pipe 20' (6.1m) L	30840020
Screen Fabric	18" (450mm) Grain-Aire Screen Fabric, 300' (91.4m) RL	1884HARL
	24" (600mm) Grain-Aire Screen Fabric, 300' (91.4m) RL	2484HARL
Screen Fabric Sleeve	12" (300mm) Grain-Aire Screen Fabric Sleeve, 21' (6.4m) L	1284HA
	15" (375mm) Grain-Aire Screen Fabric Sleeve, 21' (6.4m) L	1584HA
	18" (450mm) Grain-Aire Screen Fabric Sleeve, 21' (6.4m) L	1884HA
	24" (600mm) Grain-Aire Screen Fabric Sleeve, 21' (6.4m) L	2484HA
	30" (750mm) Grain-Aire Screen Fabric Sleeve, 21' (6.4m) L	3084HA
	36" (900mm) Grain-Aire Screen Fabric Sleeve, 21' (6.4m) L	3684HA

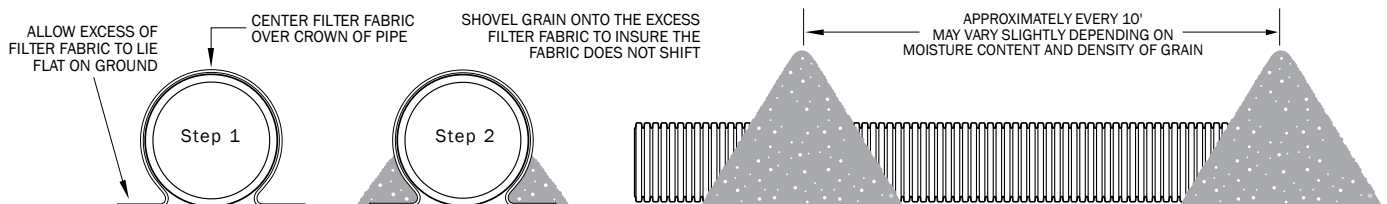

GRAIN-AIRE PIPE

SMOOTHWALL, TRIPLEWALL PIPE

3", 4", 6" SMOOTHWALL SINGLE WALL

DIAMETER	AVG. OUTSIDE DIAMETER	STANDARD LENGTHS	STYLE	PRODUCT CODE INLINE	PRODUCT CODE SPIN ON BELL*
3" (75mm)	3.25" (83mm)	10' (3.0m)	Plain	03560010	
			2-hole, 120°	03570010	
4" (100mm)	4.215" (107mm)	10' (3.0m)	Plain	04560010	04560010SP
			2-hole, 120°	04570010	04570010SP
			3-hole, 120° ⁵ / ₈ "	04580010	04580010SP
6" (150mm)	6.275" (159mm)	10' (3.0m)	Plain	06560010	
			2-hole, 120°	06570010	
			3-hole, 120°	06580010	

3", 4" ADS 3000 TRIPLEWALL®

DIAMETER	AVG. OUTSIDE DIAMETER	STANDARD LENGTHS	STYLE	PRODUCT CODE
3" (75mm)	3.25" (83mm)	10' (3.0m)	Plain	0355-0010
			2-hole	0352-0010
4" (100mm)	4.215" (107mm)	10' (3.0m)	Plain	0455-0010
			2-hole	0452-0010
			3-hole	0453-0010

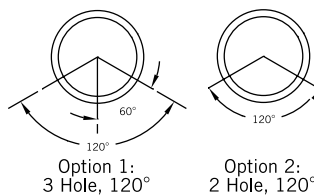
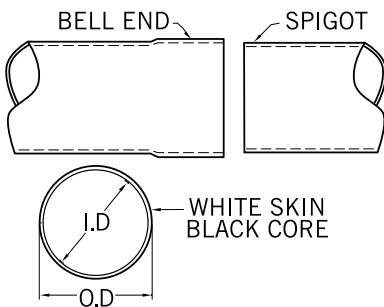

**SMOOTHWALL PIPE
TRIPLEWALL PIPE**

SOLID WALL PIPE

ADS POLYFLEX™ IPS POTABLE GRADE PRESSURE PIPE

SIDR 19 (100 psi) PE 4710

SIZE	COIL LENGTH	MAXIMUM ALLOWABLE PRESSURE AT 73° F	PRODUCT CODE
¾" (19 mm)	100' (30.5 m)	100 psi (690 kPa)	X2-75100100
¾" (19 mm)	300' (91.4 m)	100 psi (690 kPa)	X2-75100300
¾" (19 mm)	500' (152.4 m)	100 psi (690 kPa)	X2-75100500
1" (25 mm)	100' (30.5 m)	100 psi (690 kPa)	X2-1100100
1" (25 mm)	300' (91.4 m)	100 psi (690 kPa)	X2-1100300
1" (25 mm)	500' (152.4 m)	100 psi (690 kPa)	X2-1100500
1¼" (32 mm)	100' (30.5 m)	100 psi (690 kPa)	X2-125100100
1¼" (32 mm)	300' (91.4 m)	100 psi (690 kPa)	X2-125100300
1½" (38 mm)	100' (30.5 m)	100 psi (690 kPa)	X2-150100100
1½" (38 mm)	300' (91.4 m)	100 psi (690 kPa)	X2-150100300
2" (50 mm)	100' (30.5 m)	100 psi (690 kPa)	X2-2100100
2" (50 mm)	300' (91.4 m)	100 psi (690 kPa)	X2-2100300



SIDR 15 (125 psi) PE 4710

SIZE	COIL LENGTH	MAXIMUM ALLOWABLE PRESSURE AT 73° F	PRODUCT CODE
½" (13 mm)	100' (30.5 m)	125 psi (862 kPa)	X2-50125100
½" (13 mm)	300' (91.4 m)	125 psi (862 kPa)	X2-50125300



SIDR 11.5 (160 psi) PE 4710

SIZE	COIL LENGTH	MAXIMUM ALLOWABLE PRESSURE AT 73° F	PRODUCT CODE
¾" (19 mm)	100' (30.5 m)	160 psi (1103 kPa)	X2-75160100
¾" (19 mm)	300' (91.4 m)	160 psi (1103 kPa)	X2-75160300
¾" (19 mm)	500' (152.4 m)	160 psi (1103 kPa)	X2-75160500
1" (25 mm)	100' (30.5 m)	160 psi (1103 kPa)	X2-1160100
1" (25 mm)	300' (91.4 m)	160 psi (1103 kPa)	X2-1160300
1" (25 mm)	500' (152.4 m)	160 psi (1103 kPa)	X2-1160500
1¼" (32 mm)	100' (30.5 m)	160 psi (1103 kPa)	X2-125160100
1¼" (32 mm)	300' (91.4 m)	160 psi (1103 kPa)	X2-125160300
1½" (38 mm)	100' (30.5 m)	160 psi (1103 kPa)	X2-150160100
1½" (38 mm)	300' (91.4 m)	160 psi (1103 kPa)	X2-150160300
2" (50 mm)	100' (30.5 m)	160 psi (1103 kPa)	X2-2160100
2" (50 mm)	300' (91.4 m)	160 psi (1103 kPa)	X2-2160300



OTHER LENGTHS AVAILABLE. LIMITED GEOGRAPHIC AVAILABILITY.

SOLID WALL PIPE

ADS POLYFLEX IPS POTABLE GRADE PRESSURE PIPE

SIDR 9 (200 psi) PE 4710

SIZE	COIL LENGTH	MAXIMUM ALLOWABLE PRESSURE AT 73° F	PRODUCT CODE
¾" (19 mm)	100' (30.5 m)	200 psi (1379 kPa)	X2-75200100
¾" (19 mm)	300' (91.4 m)	200 psi (1379 kPa)	X2-75200300
¾" (19 mm)	500' (152.4 m)	200 psi (1379 kPa)	X2-75200500
1" (25 mm)	100' (30.5 m)	200 psi (1379 kPa)	X2-1200100
1" (25 mm)	300' (91.4 m)	200 psi (1379 kPa)	X2-1200300
1" (25 mm)	500' (152.4 m)	200 psi (1379 kPa)	X2-1200500
1¼" (32 mm)	100' (30.5 m)	200 psi (1379 kPa)	X2-125200100
1¼" (32 mm)	300' (91.4 m)	200 psi (1379 kPa)	X2-125200300
1½" (38 mm)	100' (30.5 m)	200 psi (1379 kPa)	X2-150200100
1½" (38 mm)	300' (91.4 m)	200 psi (1379 kPa)	X2-150200300
2" (50 mm)	100' (30.5 m)	200 psi (1379 kPa)	X2-2200100
2" (50 mm)	300' (91.4 m)	200 psi (1379 kPa)	X2-2200300



SIDR 7 (250 psi) PE 4710

SIZE	COIL LENGTH	MAXIMUM ALLOWABLE PRESSURE AT 73° F	PRODUCT CODE
¾" (19 mm)	100' (30.5 m)	250 psi (1724 kPa)	X2-75250100
¾" (19 mm)	300' (91.4 m)	250 psi (1724 kPa)	X2-75250300
¾" (19 mm)	500' (152.4 m)	250 psi (1724 kPa)	X2-75250500
1" (25 mm)	100' (30.5 m)	250 psi (1724 kPa)	X2-1250100
1" (25 mm)	300' (91.4 m)	250 psi (1724 kPa)	X2-1250300
1" (25 mm)	500' (152.4 m)	250 psi (1724 kPa)	X2-1250500
1¼" (32 mm)	100' (30.5 m)	250 psi (1724 kPa)	X2-125250100
1¼" (32 mm)	300' (91.4 m)	250 psi (1724 kPa)	X2-125250300
1½" (38 mm)	100' (30.5 m)	250 psi (1724 kPa)	X2-150250100
1½" (38 mm)	300' (91.4 m)	250 psi (1724 kPa)	X2-150250300
2" (50 mm)	100' (30.5 m)	250 psi (1724 kPa)	X2-2250100
2" (50 mm)	300' (91.4 m)	250 psi (1724 kPa)	X2-2250300



SOLID WALL PIPE

ADS POLYFLEX UTILITY GRADE PRESSURE PIPE

80 psi NON-POTABLE

SIZE	COIL LENGTH	MAXIMUM ALLOWABLE PRESSURE AT 73° F	PRODUCT CODE
¾" (19 mm)	100' (30.5 m)	80 psi (551 kPa)	7580100
¾" (19 mm)	300' (91.4 m)	80 psi (551 kPa)	7580300
1" (25 mm)	100' (30.5 m)	80 psi (551 kPa)	180100
1" (25 mm)	300' (91.4 m)	80 psi (551 kPa)	180300
1¼" (32 mm)	100' (30.5 m)	80 psi (551 kPa)	12580100
1¼" (32 mm)	300' (91.4 m)	80 psi (551 kPa)	12580300
1½" (38 mm)	100' (30.5 m)	80 psi (551 kPa)	15080100
1½" (38 mm)	300' (91.4 m)	80 psi (551 kPa)	15080300
2" (50 mm)	100' (30.5 m)	80 psi (551 kPa)	280100
2" (50 mm)	300' (91.4 m)	80 psi (551 kPa)	280300



100 psi NON-POTABLE

SIZE	COIL LENGTH	MAXIMUM ALLOWABLE PRESSURE AT 73° F	PRODUCT CODE
¾" (19 mm)	100' (30.5 m)	100 psi (689 kPa)	75100100
¾" (19 mm)	300' (91.4 m)	100 psi (689 kPa)	75100300
1" (25 mm)	100' (30.5 m)	100 psi (689 kPa)	1100100
1" (25 mm)	300' (91.4 m)	100 psi (689 kPa)	1100300
1¼" (32 mm)	100' (30.5 m)	100 psi (689 kPa)	125100100
1¼" (32 mm)	300' (91.4 m)	100 psi (689 kPa)	125100300
1½" (38 mm)	100' (30.5 m)	100 psi (689 kPa)	150100100
1½" (38 mm)	300' (91.4 m)	100 psi (689 kPa)	150100300
2" (50 mm)	100' (30.5 m)	100 psi (689 kPa)	2100100
2" (50 mm)	300' (91.4 m)	100 psi (689 kPa)	2100300



125 psi NON-POTABLE

SIZE	COIL LENGTH	MAXIMUM ALLOWABLE PRESSURE AT 73° F	PRODUCT CODE
½" (13 mm)	100' (30.5 m)	125 psi (862 kPa)	50125100
½" (13 mm)	300' (91.4 m)	125 psi (862 kPa)	50125300
1" (25 mm)	100' (30.5 m)	125 psi (862 kPa)	1125100
1" (25 mm)	300' (91.4 m)	125 psi (862 kPa)	1125300



UTILITY GRADE PRODUCTS AVAILABILITY VARIES BY REGION. CONTACT YOUR LOCAL ADS REPRESENTATIVE FOR MORE DETAILS.

SOLID WALL PIPE

ADS POLYFLEX COPPER TUBING SIZE PIPE

SDR 9 (250 psi) PE 4710 (BLUE)

SIZE	COIL LENGTH	MAXIMUM ALLOWABLE PRESSURE AT 73° F	PRODUCT CODE
¾" (19 mm)	100' (30.5 m)	250 psi (1724 kPa)	X4-75250100
¾" (19 mm)	300' (91.4 m)	250 psi (1724 kPa)	X4-75250300
¾" (19 mm)	500' (152.4 m)	250 psi (1724 kPa)	X4-75250500
1" (25 mm)	100' (30.5 m)	250 psi (1724 kPa)	X4-1250100
1" (25 mm)	300' (91.4 m)	250 psi (1724 kPa)	X4-1250300
1" (25 mm)	500' (152.4 m)	250 psi (1724 kPa)	X4-1250500
1¼" (32 mm)	100' (30.5 m)	250 psi (1724 kPa)	X4-125250100
1¼" (32 mm)	300' (91.4 m)	250 psi (1724 kPa)	X4-125250300
1¼" (32 mm)	500' (152.4 m)	250 psi (1724 kPa)	X4-125250500
1½" (38 mm)	100' (30.5 m)	250 psi (1724 kPa)	X4-150250100
1½" (38 mm)	300' (91.4 m)	250 psi (1724 kPa)	X4-150250300
1½" (38 mm)	500' (152.4 m)	250 psi (1724 kPa)	X4-150250500
2" (50 mm)	100' (30.5 m)	250 psi (1724 kPa)	X4-2250100
2" (50 mm)	300' (91.4 m)	250 psi (1724 kPa)	X4-2250300
2" (50 mm)	500' (152.4 m)	250 psi (1724 kPa)	X4-2250500



SDR 9 (250 psi) PE 4710 (BLACK)

SIZE	COIL LENGTH	MAXIMUM ALLOWABLE PRESSURE AT 73° F	PRODUCT CODE
¾" (19 mm)	100' (30.5 m)	250 psi (1724 kPa)	X4-75250100B
¾" (19 mm)	300' (91.4 m)	250 psi (1724 kPa)	X4-75250300B
¾" (19 mm)	500' (152.4 m)	250 psi (1724 kPa)	X4-75250500B
1" (25 mm)	100' (30.5 m)	250 psi (1724 kPa)	X4-1250100B
1" (25 mm)	300' (91.4 m)	250 psi (1724 kPa)	X4-1250300B
1" (25 mm)	500' (152.4 m)	250 psi (1724 kPa)	X4-1250500B
1¼" (32 mm)	100' (30.5 m)	250 psi (1724 kPa)	X4-125250100B
1¼" (32 mm)	300' (91.4 m)	250 psi (1724 kPa)	X4-125250300B
1¼" (32 mm)	500' (152.4 m)	250 psi (1724 kPa)	X4-125250500B
1½" (38 mm)	100' (30.5 m)	250 psi (1724 kPa)	X4-150250100B
1½" (38 mm)	300' (91.4 m)	250 psi (1724 kPa)	X4-150250300B
1½" (38 mm)	500' (152.4 m)	250 psi (1724 kPa)	X4-150250500B
2" (50 mm)	100' (30.5 m)	250 psi (1724 kPa)	X4-2250100B
2" (50 mm)	300' (91.4 m)	250 psi (1724 kPa)	X4-2250300B
2" (50 mm)	500' (152.4 m)	250 psi (1724 kPa)	X4-2250500B



COUPLERS

N-12

4" - 24" EXTERNAL SNAP COUPLERS

DIAMETER	PRODUCT CODE
4" (100mm)	0412AA
6" (150mm)	0613AA
8" (200mm)	0813AA
10" (250mm)	1013AA
12" (300mm)	1214AA
15" (375mm)	1514AA
18" (450mm)	1814AA
24" (600mm)	2414AA

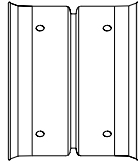

EXTERNAL SNAP COUPLER

10" - 60" SPLIT BAND COUPLERS

DIAMETER	PRODUCT CODE	
	Coupler only	Coupler with Gasket
10" (250mm)	1011AA	1066AA
12" (300mm)	1265AA	1266AA
15" (375mm)	1565AA	1566AA
18" (450mm)	1865AA	1866AA
24" (600mm)	2465AA	2412AA
30" (750mm)	3065AA	3066AA
36" (900mm)	3661AA	3662AA
42" (1050mm)	4265AA	4266AA
48" (1200mm)	4865AA	4866AA
60" (1500mm)	6065AA	6066AA

10" - 36" N-12 PLAIN END, PLAIN END DOUBLE WIDE COUPLER

DIAMETER	PRODUCT CODE
10" (250mm)	1069AA
12" (300mm)	1269AA
15" (375mm)	1569AA
18" (450mm)	1869AA
24" (600mm)	2469AA
30" (750mm)	3069AA
36" (900mm)	3669AC

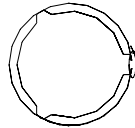

SPLIT COUPLER DOUBLE WIDE

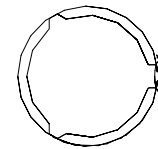
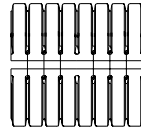

SPLIT COUPLER

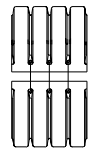

WT MITERED BELL-BELL COUPLERS 12" - 60"

DIAMETER	ANGLE	PRODUCT CODE	ANGLE	PRODUCT CODE
12" (300mm)	3°	1213ANMC03	5°	1213ANMC05
15" (375mm)	3°	1513ANMC03	5°	1513ANMC05
18" (450mm)	3°	1813ANMC03	5°	1813ANMC05
24" (600mm)	3°	2413ANMC03	5°	2413ANMC05
30" (750mm)	3°	3013ANMC03	5°	3013ANMC05
36" (900mm)	3°	3613ANMC03	5°	3613ANMC05
42" (1050mm)	3°	4213ANMC03	5°	4213ANMC05
48" (1200mm)	3°	4813ANMC03	5°	4813ANMC05
60" (1500mm)	3°	6013ANMC03	5°	6013ANMC05

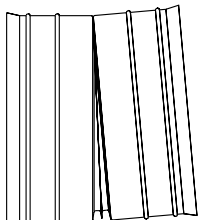

MITERED BELL/BELL COUPLER

BELL-BELL COUPLERS 12" - 60"

DIAMETER	PRODUCT CODE	
	N-12 ST	N-12WT
Double Bell Coupler + 2 gaskets		
12" (300mm)	1215AA	1215AA
15" (375mm)	1515AA	1515AA
18" (450mm)	1815AA	1815AA
24" (600mm)	2415AA	2415AA
30" (750mm)	3013AN65	3013AN65
36" (900mm)	3613AN65	3613AN65
42" (1050mm)	4213AN85	4213AN65
48" (1200mm)	4813AN85	4813AN65
60" (1500mm)	6013AN85	6013AN65

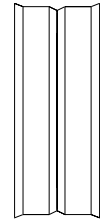

BELL/BELL COUPLER

COUPLERS

N-12

NPC INTERNAL JOINT SEAL



DIAMETER	WIDTH	PRODUCT CODE
18" (450mm)	7.5" (190mm)	1891NS
	10.5" (266mm)	1892NS
24" (600mm)	7.5" (190mm)	2491NS
	10.5" (266mm)	2492NS
30" (750mm)	7.5" (190mm)	3091NS
	10.5" (266mm)	3092NS
36" (900mm)	7.5" (190mm)	3691NS
	10.5" (266mm)	3692NS
42" (1050mm)	7.5" (190mm)	4291NS
	10.5" (266mm)	4292NS
48" (1200mm)	7.5" (190mm)	4891NS
	10.5" (266mm)	4892NS
60" (1500mm)	7.5" (190mm)	6091NS
	10.5" (266mm)	6092NS

MAR-MAC® COUPLERS



DIAMETER	PRODUCT CODE
8" (200mm)	0867RC
10" (250mm)	1067RC
12" (300mm)	1267RC
15" (375mm)	1567RC
18" (450mm)	1867RC
24" (600mm)	2467RC
30" (750mm)	3067RC
36" (900mm)	3667RC
42" (1050mm)	4267RC
48" (1200mm)	4867RC
54" (1350mm)	5467RC
60" (1500mm)	6067RC



FIELD REPAIR COUPLER - SINGLE WIDE

MAR-MAC® COUPLERS DOUBLE WIDE



DIAMETER	PRODUCT CODE
12" (300mm)	1267RCD
15" (375mm)	1567RCD
18" (450mm)	1867RCD
24" (600mm)	2467RCD
30" (750mm)	3067RCD
36" (900mm)	3667RCD
42" (1050mm)	4267RCD
48" (1200mm)	4867RCD
54" (1350mm)	5467RCD
60" (1500mm)	6067RCD

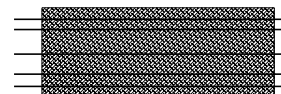

FIELD REPAIR COUPLER - DOUBLE WIDE

LUBRICANT, REPAIR KITS

LUBRICANTS



DIAMETER	BRUSH ON	BRUSH ON
	1 QUART(0.9L) PRODUCT CODE 0200LU	1 GALLON (3.8L) PRODUCT CODE 0800LU
	Typical # Joints Covered*	
4" (100mm)	89	356
6" (150mm)	61	244
8" (200mm)	43	172
10" (250mm)	33	132
12" (300mm)	25	100
15" (375mm)	20	80
18" (450mm)	16	64
24" (600mm)	10	40
30" (750mm)	9	36
36" (900mm)	7	28
42" (1050mm)	6	24
48" (1200mm)	6	24
54" (1350mm)	5	20
60" (1500mm)	5	20

* Based on joints with single gasket. Pipe with dual gaskets will require 75% more lube to cover the same number of joints.

PVC REPAIR SLEEVE

DIAMETER	PRODUCT CODE
10" (250 mm)	1075AG
12" (300 mm)	1275AG
15" (375 mm)	1575AG
18" (450 mm)	1875AG
24" (600 mm)	2475AG

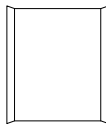

PVC REPAIR SLEEVE

TYPICALLY TWO REPAIR SLEEVES, GASKETS, LUBE AND A PIECE OF PIPE ARE NEEDED FOR POST INSTALLATION PIPE REPAIR.

NOTE: CONTACT YOUR LOCAL SALES REPRESENTATIVE FOR FIELD REPAIR OF 30"-60" (900-1500mm) DIAMETER PIPE AND FOR AVAILABILITY OF SIZES NOT LISTED.

END CAPS & ADAPTERS TO SMOOTH HDPE

N-12

12" - 60" END CAPS*

DIAMETER	N-12 PLAIN END	N-12 WT Includes 1 gasket
12" (300mm)	1201AN	1201AN65B
15" (375mm)	1501AN	1501AN65B
18" (450mm)	1801AN	1801AN65B
24" (600mm)	2401AN	2401AN65B
30" (750mm)	3001AN	3001AN65B
36" (900mm)	3601AN	3601AN65B
42" (1050mm)	4201AN	4201AN65B
48" (1200mm)	4801AN	4801AN65B
60" (1500mm)	6001AN	6001AN65B



**N-12 PLAIN END
END CAP**

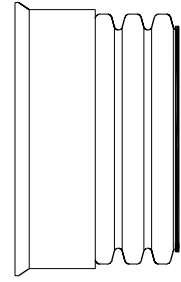

**N-12 WT
END CAP**

*END CAPS ARE FOR HORIZONTAL APPLICATIONS ONLY. END CAPS ARE NOT PERMITTED TO BE USED IN ANY VERTICAL APPLICATIONS. MISUSE OR FAILURE TO PROPERLY SECURE END CAPS MAY RESULT IN DAMAGE TO PERSONS OR PROPERTY OR MAY RESULT IN INJURY OR DEATH.

DUAL WALL SNAP END CAPS - 6" - 10"

DIAMETER	PRODUCT CODE
6" (150mm)	0667AA
8" (200mm)	0867AA
10" (250mm)	1067AA

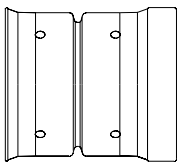

SNAP END CAP

SEWER & DRAIN ADAPTER

DIAMETER	PRODUCT CODE
4" (100mm)	0467AA

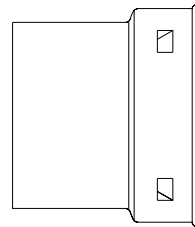

**SEWER & DRAIN
ADAPTER**

8" - 60" NON-PRESSURE PIPE END PLUG WITH GASKETS*



DIAMETER	PRODUCT CODE
8" (200mm)	0833AA
10" (250mm)	1033AA
12" (300mm)	1233AA
15" (375mm)	1533AA
18" (450mm)	1833AA
24" (600mm)	2433AA
30" (750mm)	3033AA
36" (900mm)	3633AA
42" (1050mm)	4233AA
48" (1200mm)	4833AA
60" (1500mm)	6033AA

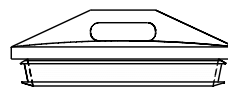
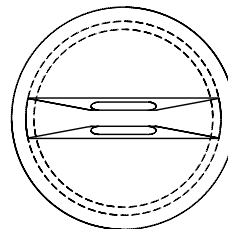

END PLUG

* NOT INTENDED FOR PERMANENT USE OR VERTICAL ORIENTATION.

NOTE: CONTACT YOUR LOCAL SALES REPRESENTATIVE FOR AVAILABILITY OF SIZES NOT LISTED ABOVE.

REDUCERS

N-12

**DUAL WALL FABRICATED
REDUCERS – 6" - 30"**

DIAMETER	N-12 PLAIN END	N-12 ST BELL-AND-SPIGOT Includes 2 gaskets	N-12 WT Includes 2 gaskets
6" x 4" (150mm x 100mm)	0670AN		
8" x 4" (200mm x 100mm)	0870AN		
8" x 6" (200mm x 150mm)	0871AN		
10" x 4" (250mm x 100mm)	1070AN		
10" x 6" (250mm x 150mm)	1071AN		
10" x 8" (250mm x 200mm)	1072AN		
12" x 4" (300mm x 100mm)	1270AN		1270AN65B
12" x 6" (300mm x 150mm)	1271AN		1271AN65B
12" x 8" (300mm x 200mm)	1272AN		1272AN65B
12" x 10" (300mm x 250mm)	1273AN		1273AN65B
15" x 4" (375mm x 100mm)	1570AN		1570AN65B
15" x 6" (375mm x 150mm)	1571AN		1571AN65B
15" x 8" (375mm x 200mm)	1572AN		1572AN65B
15" x 10" (375mm x 250mm)	1573AN		1573AN65B
15" x 12" (375mm x 300mm)	1574AN	1574AN85B	1574AN65B
18" x 4" (450mm x 100mm)	1870AN		1870AN65B
18" x 6" (450mm x 150mm)	1871AN		1871AN65B
18" x 8" (450mm x 200mm)	1872AN		1872AN65B
18" x 10" (450mm x 250mm)	1873AN		1873AN65B
18" x 12" (450mm x 300mm)	1874AN	1874AN85B	1874AN65B
18" x 15" (450mm x 375mm)	1875AN	1875AN85B	1875AN65B
24" x 4" (600mm x 100mm)	2470AN		2470AN65B
24" x 6" (600mm x 150mm)	2471AN		2471AN65B
24" x 8" (600mm x 200mm)	2472AN		2472AN65B
24" x 10" (600mm x 250mm)	2473AN		2473AN65B
24" x 12" (600mm x 300mm)	2474AN	2474AN85B	2474AN65B
24" x 15" (600mm x 375mm)	2475AN	2475AN85B	2475AN65B
24" x 18" (600mm x 450mm)	2476AN	2476AN85B	2476AN65B
30" x 4" (750mm x 100mm)	3070AN		3070AN65B
30" x 6" (750mm x 150mm)	3071AN		3071AN65B
30" x 8" (750mm x 200mm)	3072AN		3072AN65B
30" x 10" (750mm x 250mm)	3073AN		3073AN65B
30" x 12" (750mm x 300mm)	3074AN	3074AN85B	3074AN65B
30" x 15" (750mm x 375mm)	3075AN	3075AN85B	3075AN65B
30" x 18" (750mm x 450mm)	3076AN	3076AN85B	3076AN65B
30" x 24" (750mm x 600mm)	3077AN	3077AN85B	3077AN65B

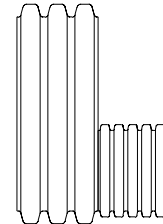

N-12 PLAIN END REDUCER

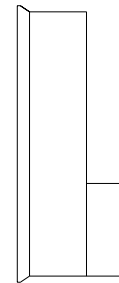

**N-12 ST AND
N-12 WT REDUCER**

NOTE: CONTACT YOUR LOCAL SALES REPRESENTATIVE FOR AVAILABILITY OF SIZES NOT LISTED ABOVE.

REDUCERS

N-12

DUAL WALL FABRICATED REDUCERS - 36" - 60"

DIAMETER	N-12 PLAIN END	N-12 ST BELL-AND-SPIGOT Includes 2 gaskets	N-12 WT Includes 2 gaskets
36" x 4" (900mm x 100mm)	3670AN		3670AN65B
36" x 6" (900mm x 150mm)	3671AN		3671AN65B
36" x 8" (900mm x 200mm)	3672AN		3672AN65B
36" x 10" (900mm x 250mm)	3673AN		3673AN65B
36" x 12" (900mm x 300mm)	3674AN	3674AN85B	3674AN65B
36" x 15" (900mm x 375mm)	3675AN	3675AN85B	3675AN65B
36" x 18" (900mm x 450mm)	3676AN	3676AN85B	3676AN65B
36" x 24" (900mm x 600mm)	3677AN	3677AN85B	3677AN65B
36" x 30" (900mm x 750mm)	3678AN	3678AN85B	3678AN65B
42" x 6" (1050mm x 150mm)	4271AN	4271AN85B	4271AN65B
42" x 8" (1050mm x 200mm)	4272AN	4272AN85B	4272AN65B
42" x 10" (1050mm x 250mm)	4273AN	4273AN85B	4273AN65B
42" x 12" (1050mm x 300mm)	4274AN	4274AN85B	4274AN65B
42" x 15" (1050mm x 375mm)	4275AN	4275AN85B	4275AN65B
42" x 18" (1050mm x 450mm)	4276AN	4276AN85B	4276AN65B
42" x 24" (1050mm x 600mm)	4277AN	4277AN85B	4277AN65B
42" x 30" (1050mm x 750mm)	4278AN	4278AN85B	4278AN65B
42" x 36" (1050mm x 900mm)	4279AN	4279AN85B	4279AN65B
48" x 12" (1200mm x 300mm)	4874AN	4874AN85B	4874AN65B
48" x 15" (1200mm x 375mm)	4875AN	4875AN85B	4875AN65B
48" x 18" (1200mm x 450mm)	4876AN	4876AN85B	4876AN65B
48" x 24" (1200mm x 600mm)	4877AN	4877AN85B	4877AN65B
48" x 30" (1200mm x 750mm)	4878AN	4878AN85B	4878AN65B
48" x 36" (1200mm x 900mm)	4879AN	4879AN85B	4879AN65B
48" x 42" (1200mm x 1050mm)	4842AN	4842AN85B	4842AN65B
60" x 24" (1500mm x 600mm)	6077AN	6077AN85B	6077AN65B
60" x 30" (1500mm x 750mm)	6078AN	6078AN85B	6078AN65B
60" x 36" (1500mm x 900mm)	6079AN	6079AN85B	6079AN65B
60" x 42" (1500mm x 1050mm)	6042AN	6042AN85B	6042AN65B
60" x 48" (1500mm x 1200mm)	6048AN	6048AN85B	6048AN65B

TOP VIEW

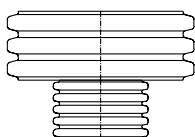

END VIEW

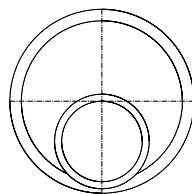

SIDE VIEW

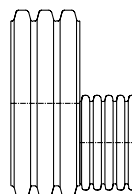

FABRICATED REDUCERS

NOTE: CONTACT YOUR LOCAL SALES REPRESENTATIVE FOR AVAILABILITY OF SIZES NOT LISTED ABOVE.

TAP REDUCERS

N-12 WT

TAP REDUCERS

DIAMETER	N-12 WT Includes 1 gasket
6" x 4" (150mm x 100mm)	0670AN65BS
8" x 4" (200mm x 100mm)	0870AN65BS
8" x 6" (200mm x 150mm)	0871AN65BS
10" x 4" (250mm x 100mm)	1070AN65BS
10" x 6" (250mm x 150mm)	1071AN65BS
10" x 8" (250mm x 200mm)	1072AN65BS
12" x 4" (300mm x 100mm)	1270AN65BS
12" x 6" (300mm x 150mm)	1271AN65BS
12" x 8" (300mm x 200mm)	1272AN65BS
15" x 4" (375mm x 100mm)	1570AN65BS
15" x 6" (375mm x 150mm)	1571AN65BS
15" x 8" (375mm x 200mm)	1572AN65BS
18" x 4" (450mm x 100mm)	1870AN65BS
18" x 6" (450mm x 150mm)	1871AN65BS
18" x 8" (450mm x 200mm)	1872AN65BS
24" x 4" (600mm x 100mm)	2470AN65BS
24" x 6" (600mm x 150mm)	2471AN65BS
24" x 8" (600mm x 200mm)	2472AN65BS
30" x 4" (750mm x 100mm)	3070AN65BS
30" x 6" (750mm x 150mm)	3071AN65BS
30" x 8" (750mm x 200mm)	3072AN65BS
36" x 4" (750mm x 100mm)	3670AN65BS
36" x 6" (750mm x 150mm)	3671AN65BS
36" x 8" (750mm x 200mm)	3672AN65BS

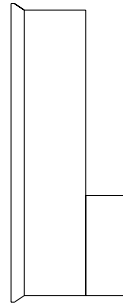

N-12 WT

BENDS

N-12

DUAL WALL FABRICATED 11.25° BENDS – 4" - 60"

DIAMETER	N-12 PLAIN END	N-12 ST Includes 2 gaskets	N-12 WT Includes 2 gaskets
4" (100mm)	0491AN		
6" (150mm)	0691AN		
8" (200mm)	0891AN		
10" (250mm)	1091AN		
12" (300mm)	1291AN	1291AN85B	1291AN65B
15" (375mm)	1591AN	1591AN85B	1591AN65B
18" (450mm)	1891AN	1891AN85B	1891AN65B
24" (600mm)	2491AN	2491AN85B	2491AN65B
30" (750mm)	3091AN	3091AN85B	3091AN65B
36" (900mm)	3691AN	3691AN85B	3691AN65B
42" (1050mm)	4291AN	4291AN85B	4291AN65B
48" (1200mm)	4891AN	4891AN85B	4891AN65B
60" (1500mm)	6091AN	6091AN85B	6091AN65B

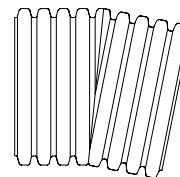

11.25° BEND
N-12 PLAIN END,
PLAIN END

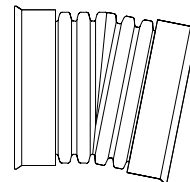

11.25° BEND
N-12 ST AND N-12
WT

DUAL WALL FABRICATED 22.5° BENDS – 4" - 60"

DIAMETER	N-12 PLAIN END	N-12 ST Includes 2 gaskets	N-12 WT Includes 2 gaskets
4" (100mm)	0492AN		
6" (150mm)	0692AN		
8" (200mm)	0892AN		
10" (250mm)	1092AN		
12" (300mm)	1292AN	1292AN85B	1292AN65B
15" (375mm)	1592AN	1592AN85B	1592AN65B
18" (450mm)	1892AN	1892AN85B	1892AN65B
24" (600mm)	2492AN	2492AN85B	2492AN65B
30" (750mm)	3092AN	3092AN85B	3092AN65B
36" (900mm)	3692AN	3692AN85B	3692AN65B
42" (1050mm)	4292AN	4292AN85B	4292AN65B
48" (1200mm)	4892AN	4892AN85B	4892AN65B
60" (1500mm)	6092AN	6092AN85B	6092AN65B

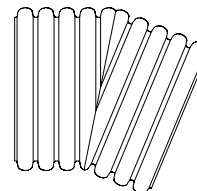

22.5° BEND
N-12 PLAIN END,
PLAIN END

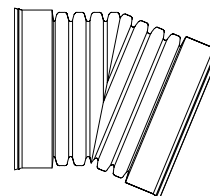

22.5° BEND
N-12 ST AND
N-12 WT

DUAL WALL FABRICATED 30° BENDS – 4" - 60"

DIAMETER	N-12 PLAIN END	N-12 ST Includes 2 gaskets	N-12 WT Includes 2 gaskets
4" (100mm)	0495AN		
6" (150mm)	0695AN		
8" (200mm)	0895AN		
10" (250mm)	1095AN		
12" (300mm)	1295AN	1295AN85B	1295AN65B
15" (375mm)	1595AN	1595AN85B	1595AN65B
18" (450mm)	1895AN	1895AN85B	1895AN65B
24" (600mm)	2495AN	2495AN85B	2495AN65B
30" (750mm)	3095AN	3095AN85B	3095AN65B
36" (900mm)	3695AN	3695AN85B	3695AN65B
42" (1050mm)	4295AN	4295AN85B	4295AN65B
48" (1200mm)	4895AN	4895AN85B	4895AN65B
60" (1500mm)	6095AN	6095AN85B	6095AN65B

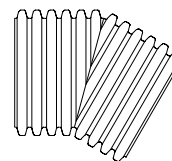

30° BEND
N-12 PLAIN END,
PLAIN END

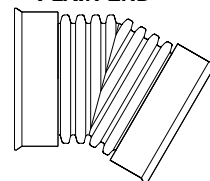

30° BEND
N-12 ST AND N-12
WT

NOTE: CONTACT YOUR LOCAL SALES REPRESENTATIVE FOR AVAILABILITY OF SIZES NOT LISTED ABOVE.

BENDS

N-12

DUAL WALL FABRICATED 45° BENDS - 12" - 60"

DIAMETER	N-12 PLAIN END	N-12 WT Includes 2 gaskets
12" (300mm)	1297AN	1297AN65BB
15" (375mm)	1597AN	1597AN65BB
18" (450mm)	1897AN	1897AN65BB
24" (600mm)	2497AN	2497AN65BB
30" (750mm)	3097AN	3097AN65BB
36" (900mm)	3697AN	3697AN65BB
42" (1050mm)	4297AN	4297AN65BB
48" (1200mm)	4897AN	4897AN65BB
60" (1500mm)	6097AN	6097AN65BB

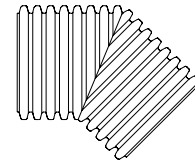

45° BEND
N-12 PLAIN END,
PLAIN END

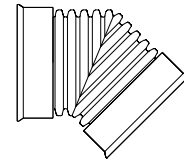

45° BEND
N-12 ST AND N-12 WT

DUAL WALL FABRICATED MITERED 45° BENDS - 12" - 60"

DIAMETER	N-12 PLAIN END	N-12 ST Includes 2 gaskets	N-12 WT Includes 2 gaskets
12" (300mm)	1294AN	1294AN85B	1294AN65B
15" (375mm)	1594AN	1594AN85B	1594AN65B
18" (450mm)	1894AN	1894AN85B	1894AN65B
24" (600mm)	2494AN	2494AN85B	2494AN65B
30" (750mm)	3094AN	3094AN85B	3094AN65B
36" (900mm)	3694AN	3694AN85B	3694AN65B
42" (1050mm)	4294AN	4294AN85B	4294AN65B
48" (1200mm)	4894AN	4894AN85B	4894AN65B
60" (1500mm)	6094AN	6094AN85B	6094AN65B

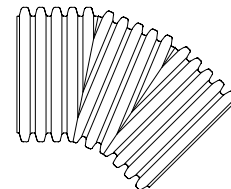

45° MITERED BEND
N-12 PLAIN END,
PLAIN END

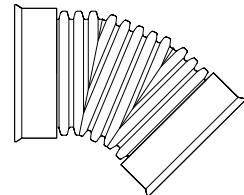

45° MITERED BEND
N-12 ST AND N-12 WT

DUAL WALL FABRICATED MITERED 90° BENDS - 12" - 18"

DIAMETER	N-12 PLAIN END	N-12 ST Includes 2 gaskets	N-12 WT Includes 2 gaskets
12" (300mm)	1299AN	1299AN85B	1299AN65B
15" (375mm)	1599AN	1599AN85B	1599AN65B
18" (450mm)	1899AN	1899AN85B	1899AN65B

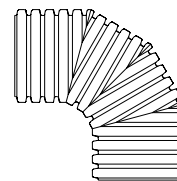

90° MITERED BEND
PLAIN END

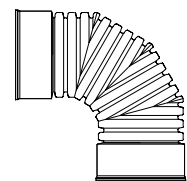

90° MITERED BEND
N-12 ST AND N-12 WT

NOTE: CONTACT YOUR LOCAL SALES REPRESENTATIVE FOR AVAILABILITY OF SIZES NOT LISTED ABOVE.

TEES

N-12

DUAL WALL FABRICATED TEES 12" - 60"

DIAMETER	N-12 PLAIN END	N-12 ST Includes 3 gaskets	N-12 WT Includes 3 gaskets
12" (300mm)	1264AN	1264AN85B	1264AN65B
15" (375mm)	1565AN	1565AN85B	1565AN65B
18" (450mm)	1866AN	1866AN85B	1866AN65B
24" (600mm)	2467AN	2467AN85B	2467AN65B
30" (750mm)	3068AN	3068AN85B	3068AN65B
36" (900mm)	3669AN	3669AN85B	3669AN65B
42" (1050mm)	4251AN	4251AN85B	4251AN65BB
48" (1200mm)	4851AN	4851AN85B	4851AN65BB
60" (1500mm)	6051AN	6051AN85B	6051AN65BB

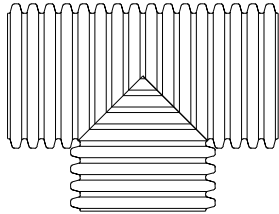

TEE N-12 PLAIN END

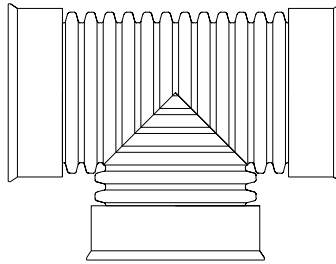

TEE N-12 ST AND N-12 WT

REDUCING TEES

N-12

DUAL WALL FABRICATED REDUCING TEES – 10" - 36"

DIAMETER	N-12 PLAIN END	N-12 ST Includes 2 main and 1 stub gasket	N-12 WT Includes 2 main and 1 stub gasket
10" x 4" (250mm x 100mm)	1060AN		
10" x 6" (250mm x 150mm)	1061AN		
10" x 8" (250mm x 200mm)	1062AN		
12" x 4" (300mm x 100mm)	1260AN	1260AN85B	1260AN65B
12" x 6" (300mm x 150mm)	1261AN	1261AN85B	1261AN65B
12" x 8" (300mm x 200mm)	1262AN	1262AN85B	1262AN65B
12" x 10" (300mm x 250mm)	1263AN	1263AN85B	1263AN65B
15" x 4" (375mm x 100mm)	1560AN	1560AN85B	1560AN65B
15" x 6" (375mm x 150mm)	1561AN	1561AN85B	1561AN65B
15" x 8" (375mm x 200mm)	1562AN	1562AN85B	1562AN65B
15" x 10" (375mm x 250mm)	1563AN	1563AN85B	1563AN65B
15" x 12" (375mm x 300mm)	1564AN	1564AN85B	1564AN65B
18" x 4" (450mm x 100mm)	1860AN	1860AN85B	1860AN65B
18" x 6" (450mm x 150mm)	1861AN	1861AN85B	1861AN65B
18" x 8" (450mm x 200mm)	1862AN	1862AN85B	1862AN65B
18" x 10" (450mm x 250mm)	1863AN	1863AN85B	1863AN65B
18" x 12" (450mm x 300mm)	1864AN	1864AN85B	1864AN65B
18" x 15" (450mm x 375mm)	1865AN	1865AN85B	1865AN65B
24" x 4" (600mm x 100mm)	2460AN	2460AN85B	2460AN65B
24" x 6" (600mm x 150mm)	2461AN	2461AN85B	2461AN65B
24" x 8" (600mm x 200mm)	2462AN	2462AN85B	2462AN65B
24" x 10" (600mm x 250mm)	2463AN	2463AN85B	2463AN65B
24" x 12" (600mm x 300mm)	2464AN	2464AN85B	2464AN65B
24" x 15" (600mm x 375mm)	2465AN	2465AN85B	2465AN65B
24" x 18" (600mm x 450mm)	2466AN	2466AN85B	2466AN65B
30" x 4" (750mm x 100mm)	3060AN	3060AN85B	3060AN65B
30" x 6" (750mm x 150mm)	3061AN	3061AN85B	3061AN65B
30" x 8" (750mm x 200mm)	3062AN	3062AN85B	3062AN65B
30" x 10" (750mm x 250mm)	3063AN	3063AN85B	3063AN65B
30" x 12" (750mm x 300mm)	3064AN	3064AN85B	3064AN65B
30" x 15" (750mm x 375mm)	3065AN	3065AN85B	3065AN65B
30" x 18" (750mm x 450mm)	3066AN	3066AN85B	3066AN65B
30" x 24" (750mm x 600mm)	3067AN	3067AN85B	3067AN65B
36" x 4" (900mm x 100mm)	3660AN	3660AN85B	3660AN65B
36" x 6" (900mm x 150mm)	3661AN	3661AN85B	3661AN65B
36" x 8" (900mm x 200mm)	3662AN	3662AN85B	3662AN65B
36" x 10" (900mm x 250mm)	3663AN	3663AN85B	3663AN65B
36" x 12" (900mm x 300mm)	3664AN	3664AN85B	3664AN65B
36" x 15" (900mm x 375mm)	3665AN	3665AN85B	3665AN65B
36" x 18" (900mm x 450mm)	3666AN	3666AN85B	3666AN65B
36" x 24" (900mm x 600mm)	3667AN	3667AN85B	3667AN65B
36" x 30" (900mm x 750mm)	3668AN	3668AN85B	3668AN65B

END VIEW

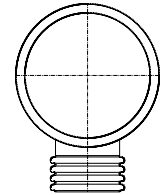

TOP VIEW

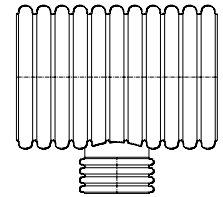

N-12 PLAIN END

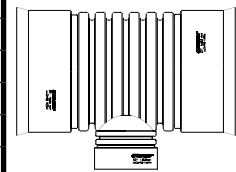

**N-12 ST
& N-12 WT**

NOTE: CONTACT YOUR LOCAL SALES REPRESENTATIVE FOR AVAILABILITY OF SIZES NOT LISTED ABOVE.

REDUCING TEES

N-12

DUAL WALL FABRICATED REDUCING TEES – 42" - 60"

DIAMETER	N-12 PLAIN END	N-12 ST Includes 2 main and 1 stub gasket	N-12 WT Includes 2 main and 1 stub gasket
42" x 4" (1050mm x 100mm)	4260AN	4260AN85B	4260AN65B
42" x 6" (1050mm x 150mm)	4261AN	4261AN85B	4261AN65B
42" x 8" (1050mm x 200mm)	4262AN	4262AN85B	4262AN65B
42" x 10" (1050mm x 250mm)	4263AN	4263AN85B	4263AN65B
42" x 12" (1050mm x 300mm)	4264AN	4264AN85B	4264AN65B
42" x 15" (1050mm x 375mm)	4265AN	4265AN85B	4265AN65B
42" x 18" (1050mm x 450mm)	4266AN	4266AN85B	4266AN65B
42" x 24" (1050mm x 600mm)	4267AN	4267AN85B	4267AN65B
42" x 30" (1050mm x 750mm)	4268AN	4268AN85B	4268AN65B
42" x 36" (1050mm x 900mm)	4269AN	4269AN85B	4269AN65B
48" x 4" (1200mm x 100mm)	4860AN	4860AN85B	4860AN65B
48" x 6" (1200mm x 150mm)	4861AN	4861AN85B	4861AN65B
48" x 8" (1200mm x 200mm)	4862AN	4862AN85B	4862AN65B
48" x 10" (1200mm x 250mm)	4863AN	4863AN85B	4863AN65B
48" x 12" (1200mm x 300mm)	4864AN	4864AN85B	4864AN65B
48" x 15" (1200mm x 375mm)	4865AN	4865AN85B	4865AN65B
48" x 18" (1200mm x 450mm)	4866AN	4866AN85B	4866AN65B
48" x 24" (1200mm x 600mm)	4867AN	4867AN85B	4867AN65B
48" x 30" (1200mm x 750mm)	4868AN	4868AN85B	4868AN65B
48" x 36" (1200mm x 900mm)	4869AN	4869AN85B	4869AN65B
48" x 42" (1200mm x 1050mm)	4840AN	4840AN85B	4840AN65B
60" x 4" (1500mm x 100mm)	6060AN	6060AN85B	6060AN65B
60" x 6" (1500mm x 150mm)	6061AN	6061AN85B	6061AN65B
60" x 8" (1500mm x 200mm)	6062AN	6062AN85B	6062AN65B
60" x 10" (1500mm x 250mm)	6063AN	6063AN85B	6063AN65B
60" x 12" (1500mm x 300mm)	6064AN	6064AN85B	6064AN65B
60" x 15" (1500mm x 375mm)	6065AN	6065AN85B	6065AN65B
60" x 18" (1500mm x 450mm)	6066AN	6066AN85B	6066AN65B
60" x 24" (1500mm x 600mm)	6067AN	6067AN85B	6067AN65B
60" x 30" (1500mm x 750mm)	6068AN	6068AN85B	6068AN65B
60" x 36" (1500mm x 900mm)	6069AN	6069AN85B	6069AN65B
60" x 42" (1500mm x 1050mm)	6040AN	6040AN85B	6040AN65B
60" x 48" (1500mm x 1200mm)	6041AN	6041AN85B	6041AN65B

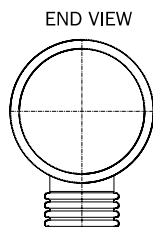

N-12 PLAIN END

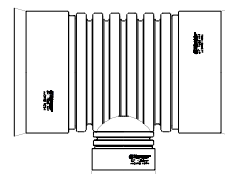
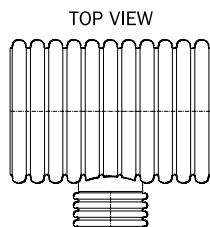

N-12 ST & N-12 WT

NOTE: CONTACT YOUR LOCAL SALES REPRESENTATIVE FOR AVAILABILITY OF SIZES NOT LISTED ABOVE.

REDUCING TAP & CROSS TEES

N-12

REDUCING HDPE TAP TEES

DIAMETER	N-12 WT Includes 2 gaskets
6" x 4" (150mm x 100mm)	0660AN65BS
8" x 4" (200mm x 100mm)	0860AN65BS
8" x 6" (200mm x 150mm)	0861AN65BS
10" x 4" (250mm x 100mm)	1060AN65BS
10" x 6" (250mm x 150mm)	1061AN65BS
10" x 8" (250mm x 200mm)	1062AN65BS
12" x 4" (300mm x 100mm)	1260AN65BS
12" x 6" (300mm x 150mm)	1261AN65BS
12" x 8" (300mm x 200mm)	1262AN65BS
15" x 4" (375mm x 100mm)	1560AN65BS
15" x 6" (375mm x 150mm)	1561AN65BS
15" x 8" (375mm x 200mm)	1562AN65BS
18" x 4" (450mm x 100mm)	1860AN65BS
18" x 6" (450mm x 150mm)	1861AN65BS
18" x 8" (450mm x 200mm)	1862AN65BS
24" x 4" (600mm x 100mm)	2460AN65BS
24" x 6" (600mm x 150mm)	2461AN65BS
24" x 8" (600mm x 200mm)	2462AN65BS
30" x 4" (750mm x 100mm)	3060AN65BS
30" x 6" (750mm x 150mm)	3061AN65BS
30" x 8" (750mm x 200mm)	3062AN65BS
36" x 4" (750mm x 100mm)	3660AN65BS
36" x 6" (750mm x 150mm)	3661AN65BS
36" x 8" (750mm x 200mm)	3662AN65BS

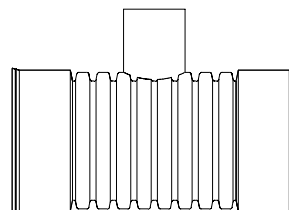

REDUCING TAP TEE

REDUCING CROSS TEES

DIAMETER	N-12 PLAIN END
6" x 4" (150mm x 100mm)	0630AN
8" x 4" (200mm x 100mm)	0830AN
8" x 6" (200mm x 150mm)	0831AN
10" x 4" (250mm x 100mm)	1030AN
10" x 6" (250mm x 150mm)	1031AN
10" x 8" (250mm x 200mm)	1032AN
12" x 4" (300mm x 100mm)	1230AN
12" x 6" (300mm x 150mm)	1231AN
12" x 8" (300mm x 200mm)	1232AN
12" x 10" (300mm x 250mm)	1233AN

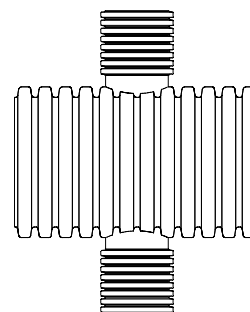

REDUCING CROSS TEE

NOTE: CONTACT YOUR LOCAL SALES REPRESENTATIVE FOR AVAILABILITY OF SIZES NOT LISTED ABOVE.

SADDLE TEES AND CROSS TEES

N-12

REDUCING SADDLE TEES

DIAMETER	N-12 ST
8" x 4" (200 mm x 100 mm)	0840AN
10" x 4" (250 mm x 100 mm)	1040AN
10" x 6" (250 mm x 150 mm)	1041AN
12" x 4" (300 mm x 100 mm)	1240AN
12" x 6" (300 mm x 150 mm)	1241AN
12" x 8" (300 mm x 200 mm)	1242AN
15" x 4" (375 mm x 100 mm)	1540AN
15" x 6" (375 mm x 150 mm)	1541AN
15" x 8" (375 mm x 200 mm)	1542AN
18" x 4" (450 mm x 100 mm)	1840AN
18" x 6" (450 mm x 150 mm)	1841AN
18" x 8" (450 mm x 200 mm)	1842AN
24" x 4" (600 mm x 100 mm)	2440AN
24" x 6" (600 mm x 150 mm)	2441AN
24" x 8" (600 mm x 200 mm)	2442AN
24" x 10" (600 mm x 250 mm)	2443AN
30" x 4" (750 mm x 100 mm)	3040AN
30" x 6" (750 mm x 150 mm)	3041AN
30" x 8" (750 mm x 200 mm)	3042AN
30" x 10" (750 mm x 250 mm)	3043AN
30" x 12" (750 mm x 300 mm)	3044AN
30" x 15" (750 mm x 375 mm)	3045AN
36" x 4" (900 mm x 100 mm)	3640AN
36" x 6" (900 mm x 150 mm)	3641AN
36" x 8" (900 mm x 200 mm)	3642AN
36" x 10" (900 mm x 250 mm)	3643AN
36" x 12" (900 mm x 300 mm)	3644AN
36" x 15" (900 mm x 375 mm)	3645AN
36" x 18" (900 mm x 450 mm)	3646AN

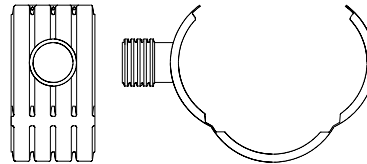

REDUCING SADDLE TEE

4" - 24" CROSS TEES

DIAMETER	N-12 PLAIN END
4" (100mm)	0430AN
6" (150mm)	0631AN
8" (200mm)	0832AN
10" (250mm)	1033AN
12" (300mm)	1234AN
15" (375mm)	1535AN
18" (450mm)	1836AN
24" (600mm)	2437AN

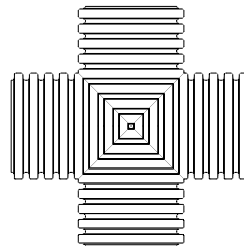

N-12 PLAIN END

WYES

N-12

**DUAL WALL FABRICATED 45°
STANDARD WYES 12" - 24"**

DIAMETER	N-12 PLAIN END	N-12 ST BELL-AND-SPIGOT Includes 3 gaskets	N-12 WT Includes 3 gaskets
12" (300mm)	1284AN	1284AN85B	1284AN65B
15" (375mm)	1585AN	1585AN85B	1585AN65B
18" (450mm)	1886AN	1886AN85B	1886AN65B
24" (600mm)	2487AN	2487AN85B	2487AN65B

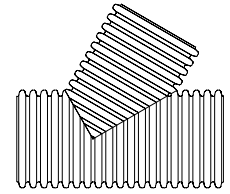

**WYE N-12 PLAIN
END**

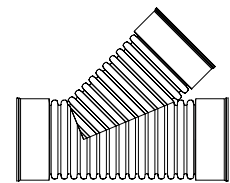

**WYE N-12 ST AND
N-12 WT**

**DUAL WALL FABRICATED 60°
STANDARD WYES 18" - 24"**

DIAMETER	N-12 PLAIN END	N-12 ST BELL-AND-SPIGOT Includes 3 gaskets	N-12 WT
18" (450mm)	1886AN60	1886AN6085B	1886AN6065B
24" (600mm)	2487AN60	2487AN6085B	2487AN6065B

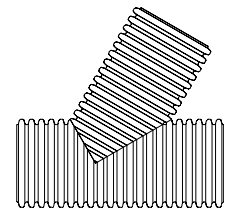

**60° WYE
N-12 PLAIN END**

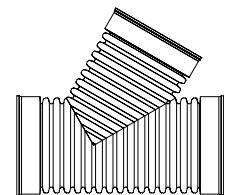

**60° WYE
N-12 ST AND N-12
WT**

REDUCING WYES

N-12

**DUAL WALL FABRICATED 45 DEGREE
REDUCING WYES – 10" - 60"**

DIAMETER	N-12 PLAIN END	N-12 ST BELL-AND-SPIGOT Includes 2 main and 1 stub gasket	N-12 WT Includes 2 main and 1 stub gasket
10" x 4" (250mm x 100mm)	1080AN		
10" x 6" (250mm x 150mm)	1081AN		
10" x 8" (250mm x 200mm)	1082AN		
12" x 4" (300mm x 100mm)	1280AN	1280AN85B	1280AN65B
12" x 6" (300mm x 150mm)	1281AN	1281AN85B	1281AN65B
12" x 8" (300mm x 200mm)	1282AN	1282AN85B	1282AN65B
12" x 10" (300mm x 250mm)	1283AN	1283AN85B	1283AN65B
15" x 4" (375mm x 100mm)	1580AN	1580AN85B	1580AN65B
15" x 6" (375mm x 150mm)	1581AN	1581AN85B	1581AN65B
15" x 8" (375mm x 200mm)	1582AN	1582AN85B	1582AN65B
15" x 10" (375mm x 250mm)	1583AN	1583AN85B	1583AN65B
15" x 12" (375mm x 300mm)	1584AN	1584AN85B	1584AN65B
18" x 4" (450mm x 100mm)	1880AN	1880AN85B	1880AN65B
18" x 6" (450mm x 150mm)	1881AN	1881AN85B	1881AN65B
18" x 8" (450mm x 200mm)	1882AN	1882AN85B	1882AN65B
18" x 10" (450mm x 250mm)	1883AN	1883AN85B	1883AN65B
18" x 12" (450mm x 300mm)	1884AN	1884AN85B	1884AN65B
18" x 15" (450mm x 375mm)	1885AN	1885AN85B	1885AN65B
24" x 4" (600mm x 100mm)	2480AN	2480AN85B	2480AN65B
24" x 6" (600mm x 150mm)	2481AN	2481AN85B	2481AN65B
24" x 8" (600mm x 200mm)	2482AN	2482AN85B	2482AN65B
24" x 10" (600mm x 250mm)	2483AN	2483AN85B	2483AN65B
24" x 12" (600mm x 300mm)	2484AN	2484AN85B	2484AN65B
30" x 4" (750mm x 100mm)	3080AN	3080AN85B	3080AN65B
30" x 6" (750mm x 150mm)	3081AN	3081AN85B	3081AN65B
30" x 8" (750mm x 200mm)	3082AN	3082AN85B	3082AN65B
30" x 10" (750mm x 250mm)	3083AN	3083AN85B	3083AN65B
30" x 12" (750mm x 300mm)	3084AN	3084AN85B	3084AN65B
30" x 15" (750mm x 375mm)	3085AN	3085AN85B	3085AN65B
36" x 4" (900mm x 100mm)	3680AN	3680AN85B	3680AN65B
36" x 6" (900mm x 150mm)	3681AN	3681AN85B	3681AN65B
36" x 8" (900mm x 200mm)	3682AN	3682AN85B	3682AN65B
36" x 10" (900mm x 250mm)	3683AN	3683AN85B	3683AN65B
36" x 12" (900mm x 300mm)	3684AN	3684AN85B	3684AN65B
36" x 15" (900mm x 375mm)	3685AN	3685AN85B	3685AN65B
36" x 18" (900mm x 450mm)	3686AN	3686AN85B	3686AN65B
42" x 4" (1050mm x 100mm)	4280AN	4280AN85B	4280AN65B
42" x 6" (1050mm x 150mm)	4281AN	4281AN85B	4281AN65B
42" x 8" (1050mm x 200mm)	4282AN	4282AN85B	4282AN65B
42" x 10" (1050mm x 250mm)	4283AN	4283AN85B	4283AN65B
42" x 12" (1050mm x 300mm)	4284AN	4284AN85B	4284AN65B
42" x 15" (1050mm x 375mm)	4285AN	4285AN85B	4285AN65B
42" x 18" (1050mm x 450mm)	4286AN	4286AN85B	4286AN65B
48" x 4" (1200mm x 100mm)	4880AN	4880AN85B	4880AN65B
48" x 6" (1200mm x 150mm)	4881AN	4881AN85B	4881AN65B
48" x 8" (1200mm x 200mm)	4882AN	4882AN85B	4882AN65B
48" x 10" (1200mm x 250mm)	4883AN	4883AN85B	4883AN65B
48" x 12" (1200mm x 300mm)	4884AN	4884AN85B	4884AN65B
48" x 15" (1200mm x 375mm)	4885AN	4885AN85B	4885AN65B
48" x 18" (1200mm x 450mm)	4886AN	4886AN85B	4886AN65B
48" x 24" (1200mm x 600mm)	4887AN	4887AN85B	4887AN65B
60" x 4" (1500mm x 100mm)	6080AN	6080AN85B	6080AN65B
60" x 6" (1500mm x 150mm)	6081AN	6081AN85B	6081AN65B
60" x 8" (1500mm x 200mm)	6082AN	6082AN85B	6082AN65B
60" x 10" (1500mm x 250mm)	6083AN	6083AN85B	6083AN65B
60" x 12" (1500mm x 300mm)	6084AN	6084AN85B	6084AN65B
60" x 15" (1500mm x 375mm)	6085AN	6085AN85B	6085AN65B
60" x 18" (1500mm x 450mm)	6086AN	6086AN85B	6086AN65B
60" x 24" (1500mm x 600mm)	6087AN	6087AN85B	6087AN65B

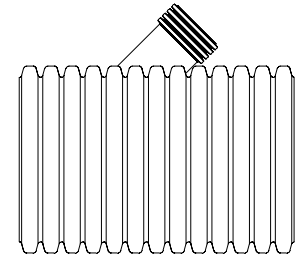

**45° REDUCING WYE
PLAIN END**

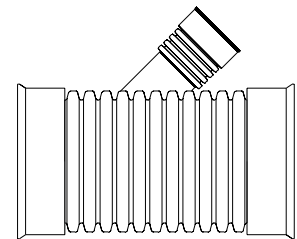

**45° REDUCING WYE N-12
ST AND
N-12 WT**

NOTE: CONTACT YOUR LOCAL SALES REPRESENTATIVE FOR AVAILABILITY OF SIZES NOT LISTED ABOVE.

REDUCING WYES

N-12

DUAL WALL FABRICATED 60 DEGREE REDUCING WYES – 18" - 60"

DIAMETER	N-12 PLAIN END	N-12 ST BELL-AND-SPIGOT Includes 2 main and 1 stub gasket	N-12 WT Includes 2 main and 1 stub gasket
18" x 4" (450mm x 100mm)	1880AN60	1880AN6085B	1880AN6065B
18" x 6" (450mm x 150mm)	1881AN60	1881AN6085B	1881AN6065B
18" x 8" (450mm x 200mm)	1882AN60	1882AN6085B	1882AN6065B
18" x 10" (450mm x 250mm)	1883AN60	1883AN6085B	1883AN6065B
18" x 12" (450mm x 300mm)	1884AN60	1884AN6085B	1884AN6065B
18" x 15" (450mm x 375mm)	1885AN60	1885AN6085B	1885AN6065B
24" x 4" (600mm x 100mm)	2480AN60	2480AN6085B	2480AN6065B
24" x 6" (600mm x 150mm)	2481AN60	2481AN6085B	2481AN6065B
24" x 8" (600mm x 200mm)	2482AN60	2482AN6085B	2482AN6065B
24" x 10" (600mm x 250mm)	2483AN60	2483AN6085B	2483AN6065B
24" x 12" (600mm x 300mm)	2484AN60	2484AN6085B	2484AN6065B
24" x 15" (600mm x 375mm)	2485AN60	2485AN6085B	2485AN6065B
24" x 18" (600mm x 450mm)	2486AN60	2486AN6085B	2486AN6065B
30" x 4" (750mm x 100mm)	3080AN60	3080AN6085B	3080AN6065B
30" x 6" (750mm x 150mm)	3081AN60	3081AN6085B	3081AN6065B
30" x 8" (750mm x 200mm)	3082AN60	3082AN6085B	3082AN6065B
30" x 10" (750mm x 250mm)	3083AN60	3083AN6085B	3083AN6065B
30" x 12" (750mm x 300mm)	3084AN60	3084AN6085B	3084AN6065B
30" x 15" (750mm x 375mm)	3085AN60	3085AN6085B	3085AN6065B
30" x 18" (750mm x 450mm)	3086AN60	3086AN6085B	3086AN6065B
30" x 24" (750mm x 600mm)	3087AN60	3087AN6085B	3087AN6065B
36" x 4" (900mm x 100mm)	3680AN60	3680AN6085B	3680AN6065B
36" x 6" (900mm x 150mm)	3681AN60	3681AN6085B	3681AN6065B
36" x 8" (900mm x 200mm)	3682AN60	3682AN6085B	3682AN6065B
36" x 10" (900mm x 250mm)	3683AN60	3683AN6085B	3683AN6065B
36" x 12" (900mm x 300mm)	3684AN60	3684AN6085B	3684AN6065B
36" x 15" (900mm x 375mm)	3685AN60	3685AN6085B	3685AN6065B
36" x 18" (900mm x 450mm)	3686AN60	3686AN6085B	3686AN6065B
36" x 24" (900mm x 600mm)	3687AN60	3687AN6085B	3687AN6065B
42" x 4" (1050mm x 100mm)	4280AN60	4280AN6085B	4280AN6065B
42" x 6" (1050mm x 150mm)	4281AN60	4281AN6085B	4281AN6065B
42" x 8" (1050mm x 200mm)	4282AN60	4282AN6085B	4282AN6065B
42" x 10" (1050mm x 250mm)	4283AN60	4283AN6085B	4283AN6065B
42" x 12" (1050mm x 300mm)	4284AN60	4284AN6085B	4284AN6065B
42" x 15" (1050mm x 375mm)	4285AN60	4285AN6085B	4285AN6065B
42" x 18" (1050mm x 450mm)	4286AN60	4286AN6085B	4286AN6065B
42" x 24" (1050mm x 600mm)	4287AN60	4287AN6085B	4287AN6065B
48" x 4" (1200mm x 100mm)	4880AN60	4880AN6085B	4880AN6065B
48" x 6" (1200mm x 150mm)	4881AN60	4881AN6085B	4881AN6065B
48" x 8" (1200mm x 200mm)	4882AN60	4882AN6085B	4882AN6065B
48" x 10" (1200mm x 250mm)	4883AN60	4883AN6085B	4883AN6065B
48" x 12" (1200mm x 300mm)	4884AN60	4884AN6085B	4884AN6065B
48" x 15" (1200mm x 375mm)	4885AN60	4885AN6085B	4885AN6065B
48" x 18" (1200mm x 450mm)	4886AN60	4886AN6085B	4886AN6065B
48" x 24" (1200mm x 600mm)	4887AN60	4887AN6085B	4887AN6065B
60" x 4" (1500mm x 100mm)	6080AN60	6080AN6085B	6080AN6065B
60" x 6" (1500mm x 150mm)	6081AN60	6081AN6085B	6081AN6065B
60" x 8" (1500mm x 200mm)	6082AN60	6082AN6085B	6082AN6065B
60" x 10" (1500mm x 250mm)	6083AN60	6083AN6085B	6083AN6065B
60" x 12" (1500mm x 300mm)	6084AN60	6084AN6085B	6084AN6065B
60" x 15" (1500mm x 375mm)	6085AN60	6085AN6085B	6085AN6065B
60" x 18" (1500mm x 450mm)	6086AN60	6086AN6085B	6086AN6065B
60" x 24" (1500mm x 600mm)	6087AN60	6087AN6085B	6087AN6065B

TOP VIEW

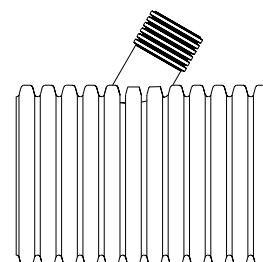

END VIEW

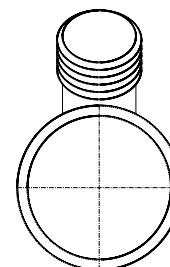

N-12 PLAIN END REDUCING WYES

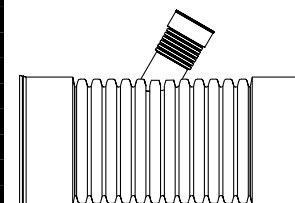

**60° REDUCING WYE
N-12 ST AND
N-12 WT**

NOTE: CONTACT YOUR LOCAL SALES REPRESENTATIVE FOR AVAILABILITY OF SIZES NOT LISTED ABOVE.

REDUCING TAP WYES

N-12 WT

REDUCING 45° TAP WYES

DIAMETER		N-12 WT Includes 2 main gaskets
6" x 4"	(150mm x 100mm)	0680AN65BS
8" x 4"	(200mm x 100mm)	0880AN65BS
8" x 6"	(200mm x 150mm)	0881AN65BS
10" x 4"	(250mm x 100mm)	1080AN65BS
10" x 6"	(250mm x 150mm)	1081AN65BS
10" x 8"	(250mm x 200mm)	1082AN65BS
12" x 4"	(300mm x 100mm)	1280AN65BS
12" x 6"	(300mm x 150mm)	1281AN65BS
12" x 8"	(300mm x 200mm)	1282AN65BS
15" x 4"	(375mm x 100mm)	1580AN65BS
15" x 6"	(375mm x 150mm)	1581AN65BS
15" x 8"	(375mm x 200mm)	1582AN65BS
18" x 4"	(450mm x 100mm)	1880AN65BS
18" x 6"	(450mm x 150mm)	1881AN65BS
18" x 8"	(450mm x 200mm)	1882AN65BS
24" x 4"	(600mm x 100mm)	2480AN65BS
24" x 6"	(600mm x 150mm)	2481AN65BS
24" x 8"	(600mm x 200mm)	2482AN65BS
30" x 4"	(750mm x 100mm)	3080AN65BS
30" x 6"	(750mm x 150mm)	3081AN65BS
30" x 8"	(750mm x 200mm)	3082AN65BS

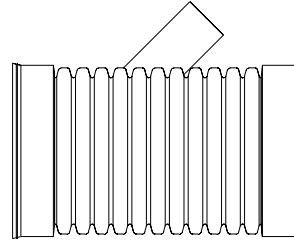

REDUCING WYE

INJECTION MOLDED FITTINGS

SOIL-TIGHT FITTINGS (Cleated Bells)

TEE, BELL/BELL

SIZE	PRODUCT CODE
4" (100mm)	0460ST
6" (150mm)	0661ST
8" (200mm)	0862ST
10" (250mm)	1063ST
12" (300mm)	1264ST

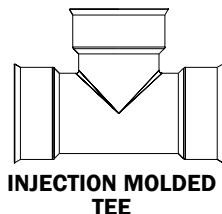

REDUCING TEE

SIZE	PRODUCT CODE
6" x 4" (150 x 100 mm)	0660ST
10" x 8" (250 x 200 mm)	1062ST
12" x 8" (300 x 200 mm)	1262ST

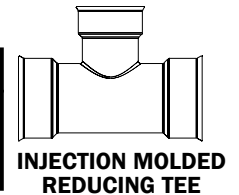

45° WYE, BELL/BELL

SIZE	PRODUCT CODE
4" (100mm)	0480ST
6" (150mm)	0681ST
8" (200mm)	0882ST
10" (250mm)	1083ST
12" (300mm)	1284ST

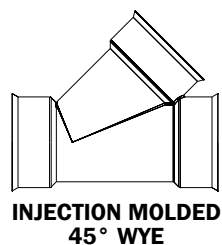

45° REDUCING WYE

SIZE	PRODUCT CODE
6" x 4" (150 x 100mm)	0680ST
8" x 4" (200 x 100mm)	0880ST
8" x 6" (200 x 150mm)	0881ST
10" x 8" (250 x 200mm)	1082ST

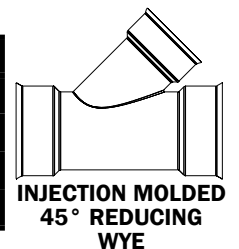

45° ELBOW, BELL/BELL

SIZE	PRODUCT CODE
4" (100mm)	0494ST
6" (150mm)	0694ST
8" (200mm)	0894ST
10" (250mm)	1094ST
12" (300mm)	1294ST

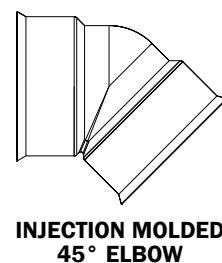

SWEEPING TEE

SIZE	PRODUCT CODE
8" x 4" (200 x 100mm)	0863ST
8" x 6" (200 x 150mm)	0836ST
10" x 6" (250 x 150mm)	1036ST

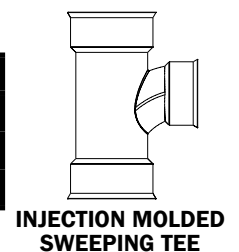

90° ELBOW, BELL/BELL

SIZE	PRODUCT CODE
4" (100mm)	0499ST
6" (150mm)	0699ST
8" (200mm)	0899ST
10" (250mm)	1099ST
12" (300mm)	1299ST

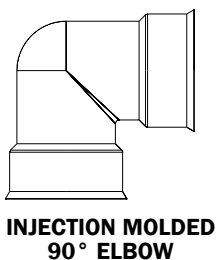

INJECTION MOLDED FITTINGS

WATERTIGHT FITTINGS (includes F477 gaskets for attachment on pipe end)

TEE, BELL/BELL

SIZE	PRODUCT CODE
4" (100mm)	0460WT
6" (150mm)	0661WT
8" (200mm)	0862WT
10" (250mm)	1063WT
12" (300mm)	1264WT

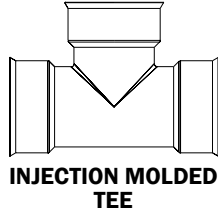

REDUCING TEE

SIZE	PRODUCT CODE
6" x 4" (150 x 100mm)	0660WT
10" x 8" (250 x 200mm)	1062WT
12" x 8" (300 x 200mm)	1262WT

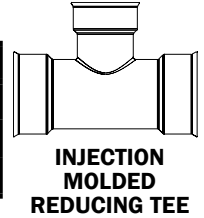

45° WYE, BELL/BELL

SIZE	PRODUCT CODE
4" (100mm)	0480WT
6" (150mm)	0681WT
8" (200mm)	0882WT
10" (250mm)	1083WT
12" (300mm)	1284WT

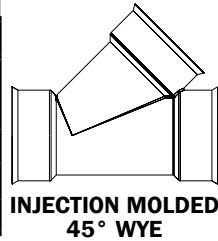

45° REDUCING WYE

SIZE	PRODUCT CODE
6" x 4" (150 x 100mm)	0680WT
8" x 4" (200 x 100mm)	0880WT
8" x 6" (200 x 150mm)	0881WT
10" x 8" (250 x 200mm)	1082WT
12" x 6" (300 x 150mm)	1281WT
12" x 8" (300 x 200mm)	1282WT

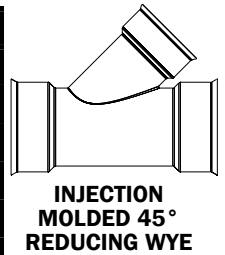

45° ELBOW, BELL/BELL

SIZE	PRODUCT CODE
4" (100mm)	0494WT
6" (150mm)	0694WT
8" (200mm)	0894WT
10" (250mm)	1094WT
12" (300mm)	1294WT

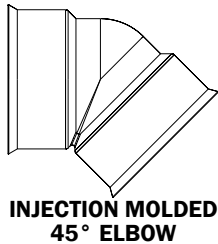

SWEEPING TEE

SIZE	PRODUCT CODE
8" x 4" (200 x 100mm)	0863WT
8" x 6" (200 x 150mm)	0836WT
10" x 6" (250 x 150mm)	1036WT
12" x 6" (300 x 150mm)	1236WT

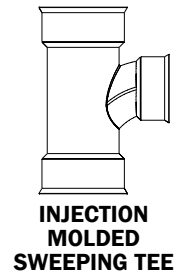

90° ELBOW, BELL/BELL

SIZE	PRODUCT CODE
4" (100mm)	0499WT
6" (150mm)	0699WT
8" (200mm)	0899WT
10" (250mm)	1099WT
12" (300mm)	1299WT

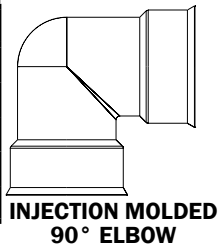

END CAP

SIZE	PRODUCT CODE
4" (100mm)	0432WT
6" (150mm)	0632WT

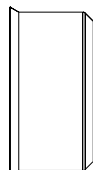

INJECTION MOLDED FITTINGS

WATERTIGHT FITTINGS

COUPLER, BELL/BELL

SIZE	PRODUCT CODE
4" (100mm)	0413WT
6" (150mm)	0613WT
8" (200mm)	0813WT
10" (250mm)	1013WT

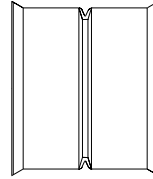

INJECTION MOLDED BELL/BELL COUPLER

REDUCING COUPLER, BELL/BELL

SIZE	PRODUCT CODE
6" x 4" (150 x 100mm)	0614WT
8" x 4" (200 x 100mm)	0814WT
8" x 6" (200 x 150mm)	0816WT
10" x 8" (250 x 200mm)	1018WT
12" x 8" (300 x 200mm)	1218WT
12" x 10" (300 x 250mm)	1210WT

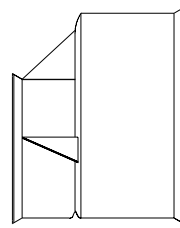

INJECTION MOLDED REDUCING BELL/BELL COUPLER

REDUCING COUPLER, BELL/SPIGOT

SIZE	PRODUCT CODE
6" x 4" (150 x 100mm)	0674WT
8" x 4" (200 x 100mm)	0874WT
8" x 6" (200 x 150mm)	0876WT

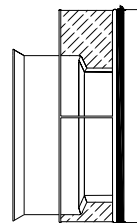

INJECTION MOLDED BELL SPIGOT REDUCER

INJECTION MOLDED REDUCING FITTING KITS N-12 ST & N-12 WT

TEE

SIZE	CONSISTS OF TEE REDUCER	N-12 ST BELL-AND-SPIGOT
10" x 4" (250mm x 100mm)	1062ST 10" x 8" + 0874WT 8" x 4"	1060ST
12" x 10" (300mm x 250mm)	1264ST 12" + 1210WT 12" x 10"	1263ST ^{1,2}

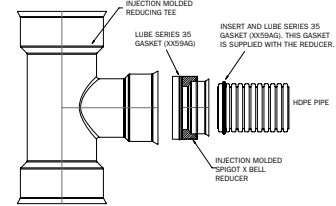

TEE

SIZE	CONSISTS OF TEE REDUCER	N-12 WT
10" x 4" (250mm x 100mm)	1062WT 10" x 8" + 0874WT 8" x 4"	1060WT
12" x 4" (300mm x 100mm)	1262WT 12" x 8" + 0874WT 8" x 4"	1260WT
12" x 10" (300mm x 250mm)	1264WT 12" + 1210WT 12" x 10"	1263WT ^{1,2}

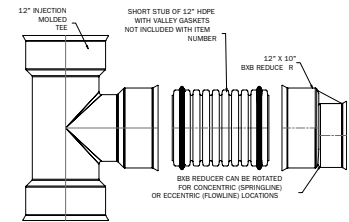

WYE

SIZE	CONSISTS OF TEE REDUCER	N-12 ST BELL-AND-SPIGOT
12" x 10" (300mm x 250mm)	1284ST 12" + 1210WT 12" x 10"	1283ST ³

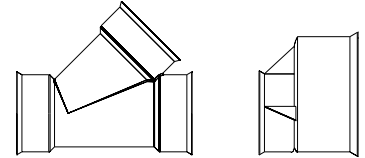

WYE

SIZE	CONSISTS OF TEE REDUCER	N-12 WT
10" x 4" (250mm x 100mm)	1082WT 10" x 8" + 0874WT 8" x 4"	1080WT
10" x 6" (250mm x 150mm)	1082WT 10" x 8" + 0876WT 8" x 6"	1081WT
12" x 4" (300mm x 100mm)	1282WT 12" x 8" + 0874WT 8" x 4"	1280WT
12" x 10" (300mm x 250mm)	1284WT 12" + 1210WT 12" x 10"	1283WT ³

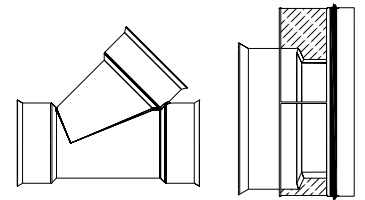

REDUCER

SIZE	CONSISTS OF TEE REDUCER	N-12 WT
10" x 4" (250mm x 100mm)	1018WT 10" x 8" + 0874WT 8" x 4"	1074WT
10" x 6" (250mm x 150mm)	1018WT 10" x 8" + 0876WT 8" x 6"	1076WT
12" x 4" (300mm x 100mm)	1218WT 12" x 8" + 0874WT 8" x 4"	1274WT
12" x 6" (300mm x 150mm)	1218WT 12" x 8" + 0876WT 8" x 6"	1276WT

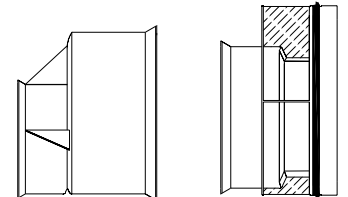

¹ Additional pipe stub not shipped with item number. Order this pipe separately.

² **12" x 10" Tee:** order 1264 (WT or ST) 12" x 12" Tee, 1210WT 12" x 10" Bell/Bell Reducer, and approximately 15" of 12" diameter dual wall pipe to make the connection between the two bell ends.

³ **12" x 10" Wye:** order 1284 (WT or ST) 12" x 12" Wye, 1210WT 12" x 10" Bell/Bell Reducer, and approximately 15" of 12" diameter dual wall pipe to make the connection between the two bell ends.

INSERTA TEE® FITTINGS

N-12 PLAIN END/N-12 ST/N-12 WT INTO SAME

DIAMETER	PRODUCT CODE
4" into 6" (100mm into 150mm)	4N126N12
4" into 8" (100mm into 200mm)	4N128N12
4" into 10" (100mm into 250mm)	4N1210N12
4" into 12" (100mm into 300mm)	4N1212N12
4" into 15" (100mm into 375mm)	4N1215N12
4" into 18" (100mm into 450mm)	4N1218N12
4" into 24" (100mm into 600mm)	4N1224N12
4" into 30" (100mm into 750mm)	4N1230N12
4" into 36" (100mm into 900mm)	4N1236N12
4" into 42" (100mm into 1050mm)	4N1242N12
4" into 48" (100mm into 1200mm)	4N1248N12
4" into 60" (100mm into 1500mm)	4N1260N12
6" into 8" (150mm into 200mm)	6N128N12
6" into 10" (150mm into 250mm)	6N1210N12
6" into 12" (150mm into 300mm)	6N1212N12
6" into 15" (150mm into 375mm)	6N1215N12
6" into 18" (150mm into 450mm)	6N1218N12
6" into 24" (150mm into 600mm)	6N1224N12
6" into 30" (150mm into 750mm)	6N1230N12
6" into 36" (150mm into 900mm)	6N1236N12
6" into 42" (150mm into 1050mm)	6N1242N12
6" into 48" (150mm into 1200mm)	6N1248N12
6" into 60" (150mm into 1500mm)	6N1260N12
8" into 10" (200mm into 250mm)	8N1210N12
8" into 12" (200mm into 300mm)	8N1212N12
8" into 15" (200mm into 375mm)	8N1215N12
8" into 18" (200mm into 450mm)	8N1218N12
8" into 24" (200mm into 600mm)	8N1224N12
8" into 30" (200mm into 750mm)	8N1230N12
8" into 36" (200mm into 900mm)	8N1236N12
8" into 42" (200mm into 1050mm)	8N1242N12
8" into 48" (200mm into 1200mm)	8N1248N12
8" into 60" (200mm into 1500mm)	8N1260N12

N-12 PLAIN END/N-12 ST/N-12 WT INTO SAME

DIAMETER	PRODUCT CODE
10" into 12" (250mm into 300mm)	10N1212N12
10" into 15" (250mm into 375mm)	10N1215N12
10" into 18" (250mm into 450mm)	10N1218N12
10" into 24" (250mm into 600mm)	10N1224N12
10" into 30" (250mm into 750mm)	10N1230N12
10" into 36" (250mm into 900mm)	10N1236N12
10" into 42" (250mm into 1050mm)	10N1242N12
10" into 48" (250mm into 1200mm)	10N1248N12
10" into 60" (250mm into 1500mm)	10N1260N12
12" into 15" (300mm into 375mm)	12N1215N12
12" into 18" (300mm into 450mm)	12N1218N12
12" into 24" (300mm into 600mm)	12N1224N12
12" into 30" (300mm into 750mm)	12N1230N12
12" into 36" (300mm into 900mm)	12N1236N12
12" into 42" (300mm into 1050mm)	12N1242N12
12" into 48" (300mm into 1200mm)	12N1248N12
12" into 60" (300mm into 1500mm)	12N1260N12
15" into 18" (375mm into 450mm)	15N1218N12
15" into 24" (375mm into 600mm)	15N1224N12
15" into 30" (375mm into 750mm)	15N1230N12
15" into 36" (375mm into 900mm)	15N1236N12
15" into 42" (375mm into 1050mm)	15N1242N12
15" into 48" (375mm into 1200mm)	15N1248N12
15" into 60" (375mm into 1500mm)	15N1260N12
18" into 24" (450mm into 600mm)	18N1224N12
18" into 30" (450mm into 750mm)	18N1230N12
18" into 36" (450mm into 900mm)	18N1236N12
18" into 42" (450mm into 1050mm)	18N1242N12
18" into 48" (450mm into 1200mm)	18N1248N12
18" into 60" (450mm into 1500mm)	18N1260N12
24" into 36" (600mm into 900mm)	24N1236N12
24" into 42" (600mm into 1050mm)	24N1242N12
24" into 48" (600mm into 1200mm)	24N1248N12
24" into 60" (600mm into 1500mm)	24N1260N12
30" into 42" (750mm into 1050mm)	30N1242N12
30" into 48" (750mm into 1200mm)	30N1248N12
30" into 60" (750mm into 1500mm)	30N1260N12

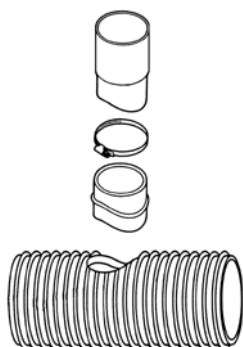

INSERTA TEE FITTINGS

SDR35 INTO N-12 PLAIN END/N-12 ST/N-12 WT

DIAMETER	PRODUCT CODE
4" SDR35 into 6" (100mm into 150mm)	4P26FB6N12
4" SDR35 into 8" (100mm into 200mm)	4P26FB8N12
4" SDR35 into 10" (100mm into 250mm)	4P26FB10N12
4" SDR35 into 12" (100mm into 300mm)	4P26FB12N12
4" SDR35 into 15" (100mm into 375mm)	4P26FB15N12
4" SDR35 into 18" (100mm into 450mm)	4P26FB18N12
4" SDR35 into 24" (100mm into 600mm)	4P26FB24N12
4" SDR35 into 30" (100mm into 750mm)	4P26FB30N12
4" SDR35 into 36" (100mm into 900mm)	4P26FB36N12
4" SDR35 into 42" (100mm into 1050mm)	4P26FB42N12
4" SDR35 into 48" (100mm into 1200mm)	4P26FB48N12
4" SDR35 into 60" (100mm into 1500mm)	4P26FB60N12
6" SDR35 into 8" (150mm into 200mm)	6P26FB8N12
6" SDR35 into 10" (150mm into 250mm)	6P26FB10N12
6" SDR35 into 12" (150mm into 300mm)	6P26FB12N12
6" SDR35 into 15" (150mm into 375mm)	6P26FB15N12
6" SDR35 into 18" (150mm into 450mm)	6P26FB18N12
6" SDR35 into 24" (150mm into 600mm)	6P26FB24N12
6" SDR35 into 30" (150mm into 750mm)	6P26FB30N12
6" SDR35 into 36" (150mm into 900mm)	6P26FB36N12
6" SDR35 into 42" (150mm into 1050mm)	6P26FB42N12
6" SDR35 into 48" (150mm into 1200mm)	6P26FB48N12
6" SDR35 into 60" (150mm into 1500mm)	6P26FB60N12
8" SDR35 into 10" (200mm into 250mm)	8P3510N12
8" SDR35 into 12" (200mm into 300mm)	8P3512N12
8" SDR35 into 15" (200mm into 375mm)	8P3515N12
8" SDR35 into 18" (200mm into 450mm)	8P3518N12
8" SDR35 into 24" (200mm into 600mm)	8P3524N12
8" SDR35 into 30" (200mm into 750mm)	8P3530N12
8" SDR35 into 36" (200mm into 900mm)	8P3536N12
8" SDR35 into 42" (200mm into 1050mm)	8P3542N12
8" SDR35 into 48" (200mm into 1200mm)	8P3548N12
8" SDR35 into 60" (200mm into 1500mm)	8P3560N12

SDR35 INTO N-12 PLAIN END/N-12 ST/N-12 WT

DIAMETER	PRODUCT CODE
10" SDR35 into 12" (250mm into 300mm)	10P3512N12
10" SDR35 into 15" (250mm into 375mm)	10P3515N12
10" SDR35 into 18" (250mm into 450mm)	10P3518N12
10" SDR35 into 24" (250mm into 600mm)	10P3524N12
10" SDR35 into 30" (250mm into 750mm)	10P3530N12
10" SDR35 into 36" (250mm into 900mm)	10P3536N12
10" SDR35 into 42" (250mm into 1050mm)	10P3542N12
10" SDR35 into 48" (250mm into 1200mm)	10P3548N12
10" SDR35 into 60" (250mm into 1500mm)	12P3560N12
12" SDR35 into 15" (300mm into 375mm)	12P3515N12
12" SDR35 into 18" (300mm into 450mm)	12P3518N12
12" SDR35 into 24" (300mm into 600mm)	12P3524N12
12" SDR35 into 30" (300mm into 750mm)	12P3530N12
12" SDR35 into 36" (300mm into 900mm)	12P3536N12
12" SDR35 into 42" (300mm into 1050mm)	12P3542N12
12" SDR35 into 48" (300mm into 1200mm)	12P3548N12
12" SDR35 into 60" (300mm into 1500mm)	12P3560N12
15" SDR35 into 18" (375mm into 450mm)	15P3518N12
15" SDR35 into 24" (375mm into 600mm)	15P3524N12
15" SDR35 into 30" (375mm into 750mm)	15P3530N12
15" SDR35 into 36" (375mm into 900mm)	15P3536N12
15" SDR35 into 42" (375mm into 1050mm)	15P3542N12
15" SDR35 into 48" (375mm into 1200mm)	15P3548N12
15" SDR35 into 60" (375mm into 1500mm)	15P3560N12
18" SDR35 into 24" (450mm into 600mm)	18P3524N12
18" SDR35 into 30" (450mm into 750mm)	18P3530N12
18" SDR35 into 36" (450mm into 900mm)	18P3536N12
18" SDR35 into 42" (450mm into 1050mm)	18P3542N12
18" SDR35 into 48" (450mm into 1200mm)	18P3548N12
18" SDR35 into 60" (450mm into 1500mm)	18P3560N12
24" SDR35 into 36" (600mm into 900mm)	24P3536N12
24" SDR35 into 42" (600mm into 1050mm)	24P3542N12
24" SDR35 into 48" (600mm into 1200mm)	24P3548N12
24" SDR35 into 60" (600mm into 1500mm)	24P3560N12
30" SDR35 into 42" (750mm into 1050mm)	30P3542N12
30" SDR35 into 48" (750mm into 1200mm)	30P3548N12
30" SDR35 into 60" (750mm into 1500mm)	30P3560N12

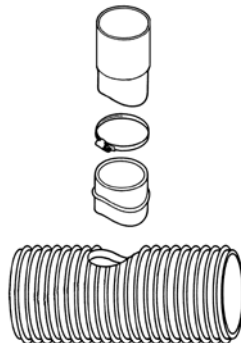

HOLE SAWS

INSERTA TEE

YELLOW SERIES (BIMETAL)

SIZE	PRODUCT CODE	PILOT DRILL	WEIGHT
4½"	Y412	¼"	2 pounds
6½"	Y612	¼"	3 pounds
8¾"	Y834	¼"	5 pounds

SILVER SERIES (USE WITH HEAVY DUTY ½" DRILL MOTOR)

SIZE	PRODUCT CODE	PILOT DRILL	WEIGHT
4½"	S412	10mm	4 pounds
6½"	S612	10mm	7½ pounds
8¾"	S834	10mm	12½ pounds

RED SERIES (HEAT TREATED TEETH)

SIZE	PRODUCT CODE	PILOT DRILL	WEIGHT
4½"	R412	⅜"	2½ pounds
6½"	R612	⅜"	3½ pounds
8¾"	R834	⅜"	5½ pounds
10⅞"	R1078	12mm	8½ pounds

GOLD SERIES (USE WITH HEAVY DUTY ½" DRILL MOTOR)

SIZE	PRODUCT CODE	PILOT DRILL	WEIGHT
4½"	GA412	¾"	12 pounds
6½"	GA612	¾"	18 pounds
8¾"	GA834	¾"	24 pounds
10⅞"	GA1078	¾"	33 pounds

BLUE SERIES (CARBON STEEL)

SIZE	PRODUCT CODE	PILOT DRILL	WEIGHT
4½"	BL412	⅜"	2½ pounds
6½"	BL612	⅜"	3½ pounds
8¾"	BL834	⅜"	5½ pounds

GOLD SERIES (USE WITH CORING MACHINE)

SIZE	PRODUCT CODE	PILOT DRILL	WEIGHT
4½"	G412	¾"	9 pounds
6½"	G612	¾"	15 pounds
8¾"	G834	¾"	21 pounds
10⅞"	G1078	¾"	30 pounds
12⅞"	G1278	¾"	41 pounds
15 ¹³ / ₁₆ "	G151316	¾"	59 pounds
19 ³ / ₁₆ "	G19316	¾"	60 pounds

GREY SERIES (CARBIDE TIPPED)

SIZE	PRODUCT CODE	PILOT DRILL	WEIGHT
4½"	PE412	½"	6 pounds
6½"	PE612	½"	8¾ pounds

ORANGE SERIES (FOR HP PIPE)

SIZE	PRODUCT CODE	PILOT DRILL	WEIGHT
4⅜"	HP438SAW	12mm	3 pounds
6⅜"	HP638SAW	12mm	4 pounds
8⅝"	HP858SAW	12mm	6 pounds
10¾"	HP1034SAW	¾"	12 pounds
12¾"	HP1234SAW	¾"	15 pounds
15¾"	HP1534SAW	¾"	21 pounds
19 ¹ / ₁₆ "	HP19116SAW	¾"	35 pounds

COUPLERS

INTERNAL SNAP, EXTERNAL SNAP & SPLIT BAND

INTERNAL COUPLERS

DIAMETER	PACKAGE QUANTITY	PRODUCT CODE
3" (75mm)	50	0315AA
4" (100mm)	16	0417AA
5" (125mm)	12	0515AA
6" (150mm)	9	0615AA
8" (200mm)	4	0815AA
10" (250mm)	4	1015AA

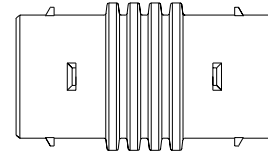

INTERNAL COUPLER

INTERNAL REDUCING COUPLERS

SIZE	PACKAGE QUANTITY	PRODUCT CODE
5" x 4" (125 x 100mm)	16	0425AA
6" x 5" (150 x 125mm)	9	0526AA

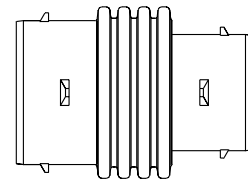

INTERNAL REDUCING COUPLER

EXTERNAL SNAP COUPLERS

DIAMETER	PACKAGE QUANTITY	PRODUCT CODE
3" (75mm)	24	0312AA
4" (100mm)	24	0412AA
		0412AABM
5" (125mm)	24	0512AA
6" (150mm)	8	0612AA
8" (200mm)	6	0812AA
10" (250mm)	3	1012AA

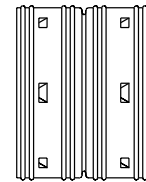

EXTERNAL SNAP COUPLER

SPLIT COUPLERS

DIAMETER	PACKAGE QUANTITY	PRODUCT CODE
3" (75mm)	36	0311AA
4" (100mm)	24	0411AA
5" (125mm)	24	0511AA
6" (150mm)	14	0611AA
8" (200mm)	8	0811AA
10" (250mm)	12	1011AA

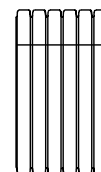

SPLIT COUPLER

END CAPS & END PLUGS

END CAPS*

DIAMETER	PACKAGE QUANTITY		TYPE	PRODUCT CODE	
	SNAP	SPLIT		SNAP	SPLIT
3" (75mm)	30	32	Solid	0332AA	0331AA
4" (100mm)	40	34	Solid	0432AA	0431AA
5" (125mm)		24	Solid		0531AA
6" (150mm)		12	Solid		0631AA
8" (200mm)	6		Solid	0832AA	
10" (250mm)	6		Solid	1032AA	
12" (300mm)		4	Solid		1267AA
15" (375mm)		1	Solid		1567AA
18" (450mm)		1	Solid		1867AA
24" (600mm)		1	Solid		2467AA

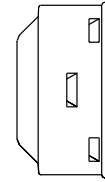

SNAP END CAP

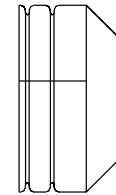

SPLIT END CAP 3"-10"

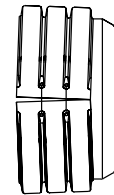

SPLIT END CAP 12"-24"

**END CAPS ARE FOR HORIZONTAL APPLICATIONS ONLY. END CAPS ARE NOT PERMITTED TO BE USED IN ANY VERTICAL APPLICATIONS. MISUSE OR FAILURE TO PROPERLY SECURE END CAPS MAY RESULT IN DAMAGE TO PERSONS OR PROPERTY OR MAY RESULT IN INJURY OR DEATH.*

INTERNAL SNAP PLUGS

DIAMETER	PACKAGE QUANTITY	PRODUCT CODE
3" (75mm)	16	0332AAIN
4" (100mm)	34	0433AAHAN
5" (125mm)	24	0533AAHAN
6" (150mm)	50	0633AAHAN

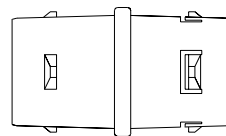

INTERNAL SNAP PLUG

INTERNAL END PLUGS

DIAMETER	PACKAGE QUANTITY	TYPE	PRODUCT CODE
3" (75mm)	100	Solid	0333AA
4" (100mm)	100	Solid	0433AA
		Perforated	0434AA
5" (125mm)	100	Solid	0533AA
6" (150mm)	50	Solid	0633AA

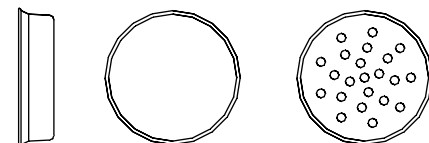

INTERNAL END PLUG - SOLID AND PERFORATED

ADAPTERS, DOWNSPOUT ADAPTERS & EXPANDABLE PIPE

ADAPTERS

DIAMETER	PACKAGE QUANTITY	TYPE	PRODUCT CODE
3" (75mm)	24	Clay	0362AA
4" (100mm)	24	Clay	0462AA
5" (125mm)	24	Clay	0562AA
6" (150mm)	11	Clay	0662AAHAN
8" (200mm)	9	Clay	0862AA
4" (100mm)	24	Sewer & Drain	0467AA
4" (100mm)	24	Septic Tank	0463AA

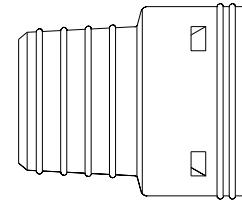

ADAPTER

DOWNSPOUT ADAPTERS

SIZE	PACKAGE QUANTITY	PRODUCT CODE
Pipe Diameter x Downspout Dimensions		
3" x 3.25" x 2.5" (75mm x 81mm x 62.5mm)	24	0364AA
4" x 3.25" x 2.5" (100mm x 81mm x 62.5mm)	24	0464AA
4" x 4.25" x 3" (100mm x 106mm x 75mm)	20	0465AA
4" x 2.56" x 2.56" (100mm x 63mm x 63mm)	24	0466AA
6" x 4" x 6" (150mm x 100mm x 150mm)	1	0664AA
6" x 4" x 6" (150mm x 100mm x 150mm)	1	0664AC*

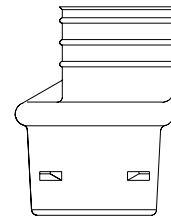

DOWNSPOUT ADAPTER

*PVC

EXPANDABLE DOWNSPOUT ADAPTERS

SIZE	PACKAGE QUANTITY	PRODUCT CODE
2" x 3" (50mm x 75mm)	6	0473AA
3" x 3" (75mm x 75 mm)	6	0474AA



BEND-A-DRAIN™ PIPE

DIAMETER	PACKAGE QUANTITY	PRODUCT CODE
4" x 12' (100mm x 3.7 m) Solid Pipe	6	335112
4" x 12' (100mm x 3.7 m) Perforated Pipe	6	330112
4" x 25' (100mm x 7.6 m) Solid Pipe	3	335125
4" x 25' (100mm x 7.6 m) Perforated Pipe	3	330125
4" x 25' (100mm x 7.6 m) Perf. Sock Pipe	3	33732585
4" x 2' (100mm x 0.6 m) Solid Repair Coupler	6	335102



REDUCERS & ELBOWS

REDUCERS*

SIZE	PACKAGE QUANTITY	PRODUCT CODE
(Main x Stub)		
4" x 3" (100mm x 75mm)	24	0314AA
5" x 4" (125mm x 100mm)	20	0514AA
6" x 4" (150mm x 100mm)	9	0614AA
6" x 5" (150mm x 125mm)	9	0516AA
8" x 6" (200mm x 150mm)	9	0816AA
10" x 8" (250mm x 200mm)	6	1018AA
12" x 10" (300mm x 250mm)	1	1210AA
15" x 12" (375mm x 300mm)	1	1512AA

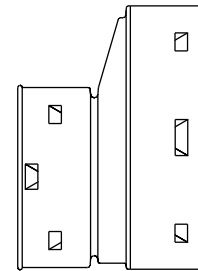

SNAP REDUCING COUPLER

90 DEGREE SNAP ELBOWS

SIZE	PACKAGE QUANTITY	PRODUCT CODE
3" (75mm)	12	0390AA
4" (100mm)	10	0490AA



90° SNAP ELBOW

45 DEGREE SNAP ELBOWS

SIZE	PACKAGE QUANTITY	PRODUCT CODE
4" (100mm)	15	0445AA



45° SNAP ELBOW

*COUPLERS SOLD SEPARATELY

TEES

BLIND, SNAP, REDUCING & BLIND MULTIPLE

BLIND TEES

SIZE	PACKAGE QUANTITY	PRODUCT CODE
3" (75mm)	12	0341AA
4" (100mm)	8	0441AA
5" (125mm)	4	0541AA
6" (150mm)	3	0641AA
8" (200mm)	1	0841AA
10" (250mm)	1	1041AA

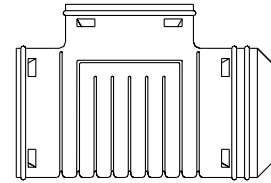

BLIND TEE

SNAP TEES

SIZE	PACKAGE QUANTITY	PRODUCT CODE
3" (75mm)	12	0321AA
4" (100mm)	8	0421AA
5" (125mm)	4	0525AA
6" (150mm)	3	0626AA

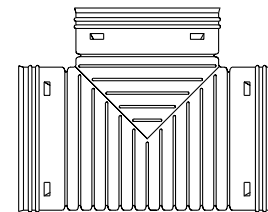

SNAP TEE

REDUCING TEES

SIZE	PACKAGE QUANTITY	PRODUCT CODE
(Main x Stub)		
5" x 3" (125mm x 75mm) Red. Tee	4	0523AA
5" x 4" (125mm x 100mm) Red. Tee	4	0524AA
6" x 4" (150mm) x 100mm) Red. Tee	3	0624AA
6" x 5" (150mm x 125mm) Red. Tee	3	0625AA

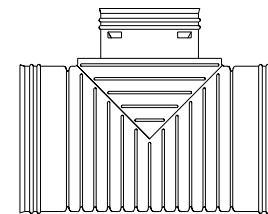

REDUCING TEE

BLIND MULTIPLE TEES

SIZE	PACKAGE QUANTITY	PRODUCT CODE
(Main x Stub)		
8" x 8"/6"/4" (200mm/150mm/100mm)	1	0845AA
10" x 10"/8" (250mm/200mm)	1	1045AA
12" x 12"/10" (300mm/250mm)	1	1247AA
15" x 10" (375mm/250mm)	1	1547AA
18" x 12" (450mm/300mm)	1	1847AA

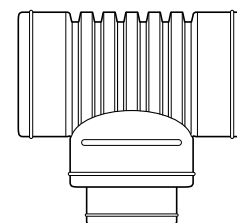

BLIND MULTIPLE TEE

TEES

MULTIPLE, MULTIPLE CROSS & INTERNAL TAP

MULTIPLE TEES

SIZE	PACKAGE QUANTITY	PRODUCT CODE
(Main x Stub)		
6" x 3"/4"/5"/6" (150mm x 75/100/125/150mm)	3	0644AA
8" x 4"/5"/6"/8" (200mm x 100/125/150/200mm)	1	0844AA
10" x 6"/8"/10" (250mm x 150/200/250mm)	1	1044AA

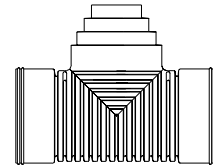

MULTIPLE TEE

MULTIPLE CROSS TEES

SIZE	PACKAGE QUANTITY	PRODUCT CODE
6" (150mm)	3	0654AA

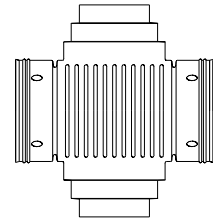

MULTIPLE CROSS TEE

INTERNAL TAP TEES

SIZE	PACKAGE QUANTITY	PRODUCT CODE
3" x 6"/8" (75mm x 150mm/200mm)	24	0350AA
4" x 6"/8" (100mm x 150mm/200mm)	24	0450AA
4" x 10"/12" (100mm x 250mm/300mm)	24	0410AA
4" x 10"/12" (100mm x 250mm/300mm)	24	0410AA

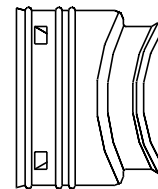

TAP TEE

HINGED TEE*

SIZE	PACKAGE QUANTITY	PRODUCT CODE
4" (100mm)	12	0421AAHF

*Fits singlewall and dual-wall pipe.



HINGED TEE

WYES

WYES

SIZE (Size on Size)	PACKAGE QUANTITY	PRODUCT CODE
3" (75mm)	7	0322AA
4" (100mm)	5	0422AA
5" (125mm)	4	0522AA
6" (150mm)	2	0622AA
8" (200mm)	1	0822AA



WYE

INTERNAL WYES

SIZE (Size on Size)	PACKAGE QUANTITY	PRODUCT CODE
3" (75mm)	12	0322AAIN

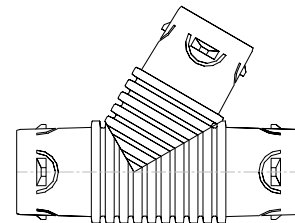

INTERNAL WYE

GRAVELLESS ACCESSORIES

GRAVELLESS ACCESSORIES

PRODUCT DESCRIPTION	STYLE	PRODUCT CODE
8" x 4" offset adapter (200mm x 100mm)	with grommet	0840AAGF
8" x 4" offset adapter (200mm x 100mm)	without grommet	0839AA
10" x 4" offset adapter (250mm x 100mm)	with grommet	1040AAGF
10" x 4" offset adapter (250mm x 100mm)	without grommet	1039AA

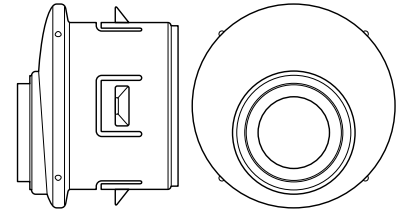

OFFSET ADAPTER

TURF FLOW

2" TURF FLOW FITTINGS

FITTINGS	PACKAGE QUANTITY	PRODUCT CODE
Coupler	50	0212AA
End cap	50	0232AA
Blind tee/elbow	50	0241AA
Reducer	25	0214AA
Tee	50	0221AA

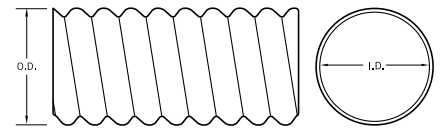

TURF FLOW COUPLER

NYLOPLAST® ROAD/ HIGHWAY STRUCTURES

ROAD/HWY STRUCTURES

STRUCTURE	GRATE DIMENSIONS	PRODUCT CODE
12" (300mm)	2' x 2' (610mm x 610mm)	3212AGS
15" (375mm)	2' x 2' (610mm x 610mm)	3215AGS
18" (450mm)	2' x 2' (610mm x 610mm)	3218AGS
18" (450mm)	2' x 3' (610mm x 914mm)	3218AGR
24" (600mm)	2' x 2' (610mm x 610mm)	3224AGS
24" (600mm)	2' x 3' (610mm x 914mm)	3224AGR
30" (750mm)	2' x 2' (610mm x 610mm)	3230AGS
30" (750mm)	2' x 3' (610mm x 914mm)	3230AGR
36" (900mm)	2' x 2' (610mm x 610mm)	3236AGS
36" (900mm)	2' x 3' (610mm x 914mm)	3236AGR

Road & Highway Structures are custom manufactured for each project. 5-10 day lead times are required for product delivery.

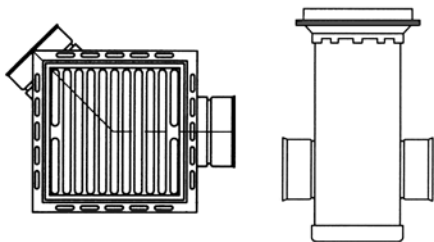

STEEL BAR GRATES AND FRAME

STRUCTURE	GRATE DIMENSIONS	PRODUCT CODE
12" (300mm)	2' x 2' (610mm x 610mm)	3212CGSQFSB
15" (375mm)	2' x 2' (610mm x 610mm)	3215CGSQFSB
18" (450mm)	2' x 2' (610mm x 610mm)	3218CGSQFSB
18" (450mm)	2' x 3' (610mm x 914mm)	3218CGRFSB
24" (600mm)	2' x 2' (610mm x 610mm)	3224CGSQFSB
24" (600mm)	2' x 3' (610mm x 914mm)	3224CGRFSB
30" (750mm)	2' x 2' (610mm x 610mm)	3230CGSQFSB
30" (750mm)	2' x 3' (610mm x 914mm)	3230CGRFSB

CURB INLET STRUCTURES

CURB INLET STRUCTURES

STRUCTURE	GRATE DIMENSIONS	PRODUCT CODE
12" (300mm)	2' x 2' (610mm x 610mm)	3012AGS
15" (375mm)	2' x 2' (610mm x 610mm)	3015AGS
18" (450mm)	2' x 2' (610mm x 610mm)	3018AGS
18" (450mm)	2' x 3' (610mm x 914mm)	3018AGR
24" (600mm)	2' x 2' (610mm x 610mm)	3024AGS
24" (600mm)	2' x 3' (610mm x 914mm)	3024AGR
30" (750mm)	2' x 2' (610mm x 610mm)	3030AGS
30" (750mm)	2' x 3' (610mm x 914mm)	3030AGR
36" (900mm)	2' x 2' (610mm x 610mm)	3036AGS
36" (900mm)	2' x 3' (610mm x 914mm)	3036AGR

Curb Inlet Structures are custom manufactured for each project. 5-10 day lead times are required for product delivery.

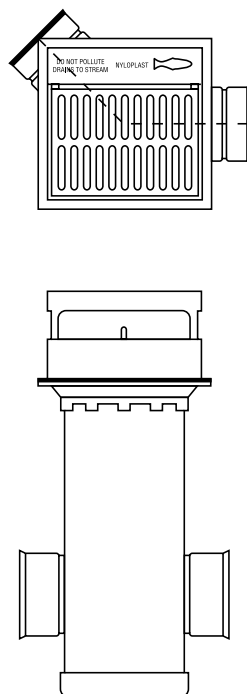

Grate Options

2' x 2' Grate Options

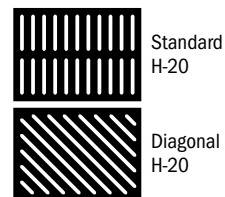

2' x 3' Grate Options

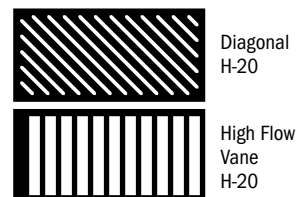

DRAIN BASINS

DRAIN BASINS*

STRUCTURE	STUB DIMENSIONS	PRODUCT CODE
8" (200mm)	4" (100mm) thru 8" (200mm)	2808AG
10" (250mm)	4" (100mm) thru 10" (250mm)	2810AG
12" (300mm)	4" (100mm) thru 12" (300mm)	2812AG
15" (375mm)	4" (100mm) thru 15" (375mm)	2815AG
18" (450mm)	4" (100mm) thru 18" (450mm)	2818AG
24" (600mm)	4" (100mm) thru 24" (600mm)	2824AG
30" (750mm)	4" (100mm) thru 30" (750mm)	2830AG
36" (900mm)	4" (100mm) thru 36" (900mm)	2836AG

*Drain Basin Structures are custom manufactured for each project. 5-10 day lead times are required for product delivery.

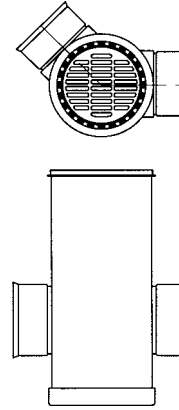

DRAIN BASINS WITH WEIR*

STRUCTURE	STUB DIMENSIONS	PRODUCT CODE
24" (600mm)	4" (100mm) thru 24" (600mm)	2824AGWE
30" (750mm)	4" (100mm) thru 30" (750mm)	2830AGWE
36" (900mm)	4" (100mm) thru 30" (750mm)	2836AGWE

*Contact Nyloplast for Weir heights greater than 84" (2134 mm).



INLINE DRAINS

INLINE DRAINS

DRAIN BASIN	ADAPTS TO PIPE DIAMETER	PRODUCT CODE
8" (200mm)	4" (100mm), 6" (150mm), 8" (200mm)	2708AG
10" (250mm)	4" (100mm), 6" (150mm), 8" (200mm), 10" (250mm)	2710AG
12" (300mm)	4" (100mm), 6" (150mm), 8" (200mm), 10" (250mm), 12" (300mm)	2712AG
15" (375mm)	4" (100mm), 6" (150mm), 8" (200mm), 10" (250mm), 12" (300mm), 15" (375mm)	2715AG
18" (450mm)	4" (100mm), 6" (150mm), 8" (200mm), 10" (250mm), 12" (300mm), 15" (375mm), 18" (450mm)	2718AG
24" (600mm)	4" (100mm), 6" (150mm), 8" (200mm), 10" (250mm), 12" (300mm), 15" (375mm), 18" (450mm), 24" (600mm),	2724AG
30" (750mm)	4" (100mm), 6" (150mm), 8" (200mm), 10" (250mm), 12" (300mm), 15" (375mm), 18" (450mm), 24" (600mm), 30" (750mm)	2730AG

3-7 day lead times are required for product delivery.

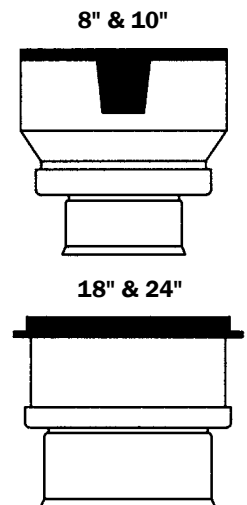

DRAIN BASIN & INLINE DRAIN GRATE OPTIONS



Dome - Light-Duty

8" (200mm) - 0899CGD
10" (250mm) - 1099CGD
12" (300mm) - 1299CGD
15" (375mm) - 1599CGD
18" (450mm) - 1899CGD
24" (600mm) - 2199CGD



Standard - Light-Duty

8" (200mm) - 0899CGS
10" (250mm) - 1099CGS



Light-Duty Bronze

8" (200mm) - 0899CGB
10" (250mm) - 1099CGB



Solid - Light-Duty

8" (200mm) - 0899CGC
10" (250mm) - 1099CGC

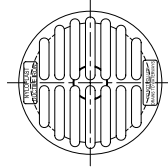

Standard H-20

18" (450mm) - 1899CGS



Solid H-20

18" (450mm) - 1899CGC
24" (600mm) - 2499CGC

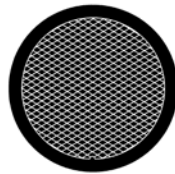

Solid H-20

30" (750mm) - 3099CGC



Standard H-20

24" (600mm) - 2499CGS



Standard H-20

30" (750mm) - 3099CGS



Pedestrian H-10

18" (450mm) - 1899CGP



Pedestrian H-10

24" (600mm) - 2499CGP

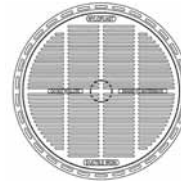

Pedestrian H-20

30" (750mm) - 3099CGP

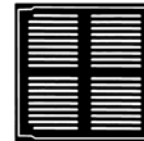

Pedestrian H-10

12" (300mm) - 1299CGP
15" (375mm) - 1599CGP
Hinged Design



Bronze Pedestrian - Light-Duty

12" (300mm) - 1299CGPB
15" (375mm) - 1599CGPB

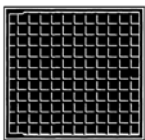

Solid H-20

12" (300mm) - 1299CGC
15" (375mm) - 1599CGC
Hinged Design

(Locking option is available for most grates)

DROP-IN GRATES

LIGHT DUTY DROP-IN GRATES

SIZE	PRODUCT CODE
6" (150mm)	0601DI
8" (200mm)	0801DI
10" (250mm)	1001DI
12" (300mm)	1201DI
15" (375mm)	1501DI
18" (450mm)	1801DI
24" (600mm)	2401DI



Fits inside Sewer SDR 35
Pipe and IPS SCH 40 Pipe

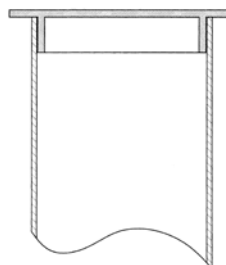

Fits inside N-12 Dual Wall Pipe

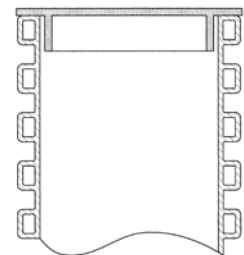

WATER CONTROL STRUCTURE

WATER CONTROL STRUCTURE

SIZE	PRODUCT CODE
12" (300mm) Diameter Drain Basin	4912AG
15" (375mm) Diameter Drain Basin	4915AG
18" (450mm) Diameter Drain Basin	4918AG
24" (600mm) Diameter Drain Basin	4924AG

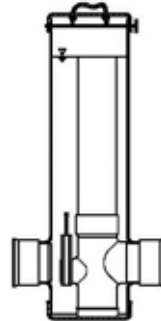

SUMP INSERTS

SUMP INSERTS

BASIN DIAMETER	PRODUCT CODE
12" (300mm)	3812AGSI
15" (375mm)	3815AGSI
18" (450mm)	3818AGSI
24" (600mm)	3824AGSI
30" (750mm)	3830AGSI

ADD-A-BRANCH

ADD-A-BRANCH

SIZE	ADAPTS TO STRUCTURE	PRODUCT CODE
4" (100mm) Field Installation Kit	Adapts to 8"-24" (200-600mm) Structure	6004AG _
4" (100mm) Field Installation Kit	Adapts to 30" (750mm) Structure	6004AG _ 30
6" (150mm) Field Installation Kit	Adapts to 10"-24" (250-600mm) Structure	6006AG _
6" (150mm) Field Installation Kit	Adapts to 30" (750mm) Structure	606AG _ 30
8" (200mm) Field Installation Kit	Adapts to 12"-24" (300-600mm) Structure	6008AG _
8" (200mm) Field Installation Kit	Adapts to 30" (750mm) Structure	6008AG _ 30
10" (250mm) Field Installation Kit	Adapts to 15"-24" (375-600mm) Structure	6010AG _
10" (250mm) Field Installation Kit	Adapts to 30" (750mm) Structure	6010AG _ 30
12" (300mm) Field Installation Kit	Adapts to 18" & 24" (450 & 600mm) Structure	6012AG _
12" (300mm) Field Installation Kit	Adapts to 30" (750mm) Structure	6012AG _ 30
15" (375mm) Field Installation Kit	Adapts to 24" (600mm) Structure	6015AG _
15" (375mm) Field Installation Kit	Adapts to 30" (750mm) Structure	6015AG _ 30
18" (450mm) Field Installation Kit	Adapts to 30" (750mm) Structure	6018AG _ 30



COUPLINGS & ADAPTERS

DUAL WALL CORRUGATED COUPLING

SIZE	PRODUCT CODE
4" (100mm)	0471AG
6" (150mm)	0671AG
8" (200mm)	0871AG
10" (250mm)	1071AG
12" (300mm)	1271AG
15" (375mm)	1571AG
18" (450mm)	1871AG
24" (600mm)	2471AG

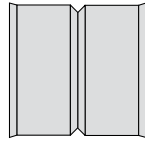

CORRUGATED COUPLING

DUAL WALL CORRUGATED ADAPTER WITH SDR 35 SPIGOT

SIZE	PRODUCT CODE
4" (100mm)	0468AG
6" (150mm)	0668AG
8" (200mm)	0868AG
10" (250mm)	1068AG
12" (300mm)	1268AG
15" (375mm)	1568AG
18" (450mm)	1868AG
24" (600mm)	2468AG

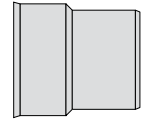

ADAPTER WITH SDR 35 SPIGOT

DUAL WALL CORRUGATED ADAPTER WITH SDR 35 BELL

SIZE	PRODUCT CODE
4" (100mm)	0469AG
6" (150mm)	0669AG
8" (200mm)	0869AG
10" (250mm)	1069AG
12" (300mm)	1269AG
15" (375mm)	1569AG
18" (450mm)	1869AG
24" (600mm)	2469AG

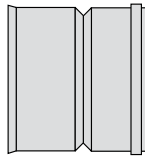

ADAPTER WITH SDR 35 BELL

DUAL WALL CORRUGATED ADAPTER WITH SCHEDULE 40 SPIGOT

SIZE	PRODUCT CODE
4" (100mm)	0478AG
6" (150mm)	0678AG
8" (200mm)	0878AG
10" (250mm)	1078AG
12" (300mm)	1278AG
15" (375mm)	1578AG
18" (450mm)	1878AG
24" (600mm)	2478AG

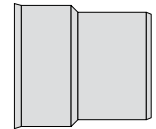

ADAPTER WITH SCH 40 SPIGOT

DUAL WALL CORRUGATED ADAPTER WITH SCHEDULE 40 BELL

SIZE	PRODUCT CODE
4" (100mm)	0479AG
6" (150mm)	0679AG
8" (200mm)	0879AG
10" (250mm)	1079AG
12" (300mm)	1279AG
15" (375mm)	1579AG
18" (450mm)	1879AG
24" (600mm)	2479AG

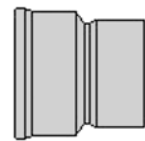

ADAPTER WITH SCH 40 BELL

CLEAN OUT PLUGS

SIZE	PRODUCT CODE
4" (100mm)	0474AG
6" (150mm)	0674AG
8" (200mm)	0874AG
10" (250mm)	1074AG
12" (300mm)	1274AG

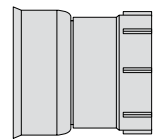

CLEAN OUT PLUG

REPAIR COUPLING

SIZE	PRODUCT CODE
4" (100mm)	0475AG
6" (150mm)	0675AG
8" (200mm)	0875AG
10" (250mm)	1075AG
12" (300mm)	1275AG
15" (375mm)	1575AG
18" (450mm)	1875AG
24" (600mm)	2475AG

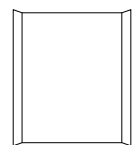

PVC REPAIR SLEEVE

NOTE: GASKET NOT REQUIRED FOR SDR 35 OR SCH 40 PORTION OF FITTING.

TEES

DUAL WALL TEE WITH DUAL WALL N-12 GASKETED BRANCH

SIZE	PRODUCT CODE
10" (250mm) x 4" (100mm)	1081AG
10" (250mm) x 6" (150mm)	1082AG
10" (250mm) x 8" (200mm)	1083AG
10" (250mm) x 10" (250mm)	1084AG
12" (300mm) x 4" (100mm)	1281AG
12" (300mm) x 6" (150mm)	1282AG
12" (300mm) x 8" (200mm)	1283AG
12" (300mm) x 10" (250mm)	1284AG
12" (300mm) x 12" (300mm)	1285AG
15" (375mm) x 4" (100mm)	1581AG
15" (375mm) x 6" (150mm)	1582AG
15" (375mm) x 8" (200mm)	1583AG
15" (375mm) x 10" (250mm)	1584AG
15" (375mm) x 12" (300mm)	1585AG
15" (375mm) x 15" (375mm)	1586AG
18" (450mm) x 4" (100mm)	1881AG
18" (450mm) x 6" (150mm)	1882AG
18" (450mm) x 8" (200mm)	1883AG
18" (450mm) x 10" (250mm)	1884AG
18" (450mm) x 12" (300mm)	1885AG
18" (450mm) x 15" (375mm)	1886AG
18" (450mm) x 18" (450mm)	1887AG
24" (600mm) x 4" (100mm)	2481AG
24" (600mm) x 6" (150mm)	2482AG
24" (600mm) x 8" (200mm)	2483AG
24" (600mm) x 10" (250mm)	2484AG
24" (600mm) x 12" (300mm)	2485AG
24" (600mm) x 15" (375mm)	2486AG
24" (600mm) x 18" (450mm)	2487AG
24" (600mm) x 24" (600mm)	2488AG

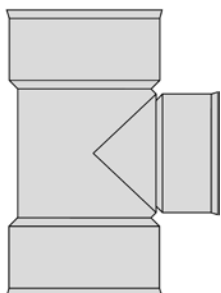

TEE WITH BRANCH

DUAL WALL CORRUGATED TEE WITH SDR 35 BRANCH

SIZE	PRODUCT CODE
10" (250mm) x 4" (100mm)	1061AG
10" (250mm) x 6" (150mm)	1062AG
10" (250mm) x 8" (200mm)	1063AG
10" (250mm) x 10" (250mm)	1064AG
12" (300mm) x 4" (100mm)	1261AG
12" (300mm) x 6" (150mm)	1262AG
12" (300mm) x 8" (200mm)	1263AG
12" (300mm) x 10" (250mm)	1264AG
12" (300mm) x 12" (300mm)	1265AG
15" (375mm) x 4" (100mm)	1561AG
15" (375mm) x 6" (150mm)	1562AG
15" (375mm) x 8" (200mm)	1563AG
15" (375mm) x 10" (250mm)	1564AG
15" (375mm) x 12" (300mm)	1565AG
15" (375mm) x 15" (375mm)	1566AG
18" (450mm) x 4" (100mm)	1861AG
18" (450mm) x 6" (150mm)	1862AG
18" (450mm) x 8" (200mm)	1863AG
18" (450mm) x 10" (250mm)	1864AG
18" (450mm) x 12" (300mm)	1865AG
18" (450mm) x 15" (375mm)	1866AG
18" (450mm) x 18" (450mm)	1867AG
24" (600mm) x 4" (100mm)	2461AG
24" (600mm) x 6" (150mm)	2462AG
24" (600mm) x 8" (200mm)	2463AG
24" (600mm) x 10" (250mm)	2464AG
24" (600mm) x 12" (300mm)	2465AG
24" (600mm) x 15" (375mm)	2466AG
24" (600mm) x 18" (450mm)	2467AG

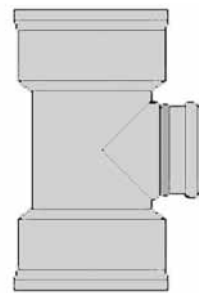

TEE WITH SDR 35 BRANCH

WYES

DUAL WALL CORRUGATED WYE WITH N-12 GASKETED BRANCH

SIZE	PRODUCT CODE
10" (250mm) x 4" (100mm)	1091AG
10" (250mm) x 6" (150mm)	1092AG
10" (250mm) x 8" (200mm)	1093AG
10" (250mm) x 8" (200mm)	1094AG
12" (300mm) x 4" (100mm)	1291AG
12" (300mm) x 6" (150mm)	1292AG
12" (300mm) x 8" (200mm)	1293AG
12" (300mm) x 10" (250mm)	1294AG
12" (300mm) x 12" (300mm)	1295AG
15" (375mm) x 4" (100mm)	1591AG
15" (375mm) x 6" (150mm)	1592AG
15" (375mm) x 8" (200mm)	1593AG
15" (375mm) x 10" (250mm)	1594AG
15" (375mm) x 12" (300mm)	1595AG
15" (375mm) x 15" (375mm)	1596AG
18" (450mm) x 4" (100mm)	1891AG
18" (450mm) x 6" (150mm)	1892AG
18" (450mm) x 8" (200mm)	1893AG
18" (450mm) x 10" (250mm)	1894AG
18" (450mm) x 12" (300mm)	1895AG
18" (450mm) x 15" (375mm)	1896AG
18" (450mm) x 18" (450mm)	1897AG
24" (600mm) x 4" (100mm)	2491AG
24" (600mm) x 6" (150mm)	2492AG
24" (600mm) x 8" (200mm)	2493AG
24" (600mm) x 10" (250mm)	2494AG
24" (600mm) x 12" (300mm)	2495AG
24" (600mm) x 15" (375mm)	2496AG
24" (600mm) x 18" (450mm)	2497AG
24" (600mm) x 24" (600mm)	2498AG

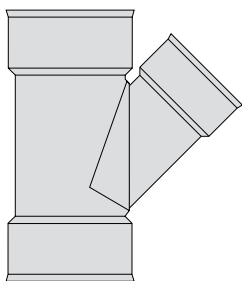

WYE WITH BRANCH

DUAL WALL CORRUGATED WYE WITH SDR 35 BRANCH

SIZE	PRODUCT CODE
4" (100mm) x 4" (100mm)	0401AG
6" (150mm) x 4" (100mm)	0601AG
6" (150mm) x 6" (150mm)	0602AG
8" (200mm) x 4" (100mm)	0801AG
8" (200mm) x 6" (150mm)	0802AG
8" (200mm) x 8" (200mm)	0803AG
10" (250mm) x 4" (100mm)	1001AG
10" (250mm) x 6" (150mm)	1002AG
10" (250mm) x 8" (200mm)	1003AG
10" (250mm) x 10" (250mm)	1004AG
12" (300mm) x 4" (100mm)	1201AG
12" (300mm) x 6" (150mm)	1202AG
12" (300mm) x 8" (200mm)	1203AG
12" (300mm) x 10" (250mm)	1204AG
12" (300mm) x 12" (300mm)	1205AG
15" (375mm) x 4" (100mm)	1501AG
15" (375mm) x 6" (150mm)	1502AG
15" (375mm) x 8" (200mm)	1503AG
15" (375mm) x 10" (250mm)	1504AG
15" (375mm) x 12" (300mm)	1505AG
15" (375mm) x 15" (375mm)	1506AG
18" (450mm) x 4" (100mm)	1801AG
18" (450mm) x 6" (150mm)	1802AG
18" (450mm) x 8" (200mm)	1803AG
18" (450mm) x 10" (250mm)	1804AG
18" (450mm) x 12" (300mm)	1805AG
18" (450mm) x 15" (375mm)	1806AG
18" (450mm) x 18" (450mm)	1807AG
24" (600mm) x 4" (100mm)	2401AG
24" (600mm) x 6" (150mm)	2402AG
24" (600mm) x 8" (200mm)	2403AG
24" (600mm) x 10" (250mm)	2404AG
24" (600mm) x 12" (300mm)	2405AG
24" (600mm) x 15" (375mm)	2406AG
24" (600mm) x 18" (450mm)	2407AG
24" (600mm) x 24" (600mm)	2408AG

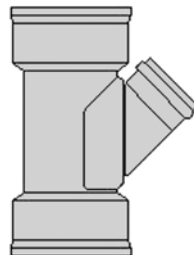

WYE WITH SDR 35 BRANCH

SWEEPING TEE & REDUCER

SWEEPING TEE WITH N-12 GASKETED BRANCH

SIZE	PRODUCT CODE
4" (100mm) x 4" (100mm)	0435AG
6" (150mm) x 4" (100mm)	0635AG
6" (150mm) x 6" (150mm)	0636AG
8" (200mm) x 4" (100mm)	0835AG
8" (200mm) x 6" (150mm)	0836AG
8" (200mm) x 8" (200mm)	0837AG
10" (250mm) x 4" (100mm)	1035AG
10" (250mm) x 6" (150mm)	1036AG
10" (250mm) x 8" (200mm)	1037AG
12" (300mm) x 4" (100mm)	1235AG
12" (300mm) x 6" (150mm)	1236AG
12" (300mm) x 8" (200mm)	1237AG
15" (375mm) x 4" (100mm)	1535AG
15" (375mm) x 6" (150mm)	1536AG
15" (375mm) x 8" (200mm)	1537AG
18" (450mm) x 4" (100mm)	1835AG
18" (450mm) x 6" (150mm)	1836AG
18" (450mm) x 8" (200mm)	1837AG
24" (600mm) x 4" (100mm)	2435AG
24" (600mm) x 6" (150mm)	2436AG
24" (600mm) x 8" (200mm)	2437AG

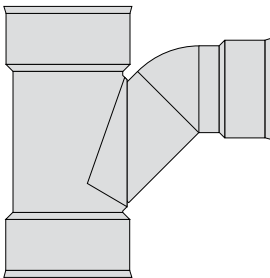

SWEEPING TEE

CONCENTRIC REDUCER WITH N-12 GASKETED BRANCH

SIZE	PRODUCT CODE
6" (150mm) x 4" (100mm)	0611AG
8" (200mm) x 4" (100mm)	0811AG
8" (200mm) x 8" (200mm)	0812AG
10" (250mm) x 4" (100mm)	1011AG
10" (250mm) x 6" (150mm)	1012AG
10" (250mm) x 8" (200mm)	1013AG
12" (300mm) x 4" (100mm)	1211AG
12" (300mm) x 6" (150mm)	1212AG
12" (300mm) x 8" (200mm)	1213AG
12" (300mm) x 10" (250mm)	1214AG
15" (375mm) x 4" (100mm)	1511AG
15" (375mm) x 6" (150mm)	1512AG
15" (375mm) x 8" (200mm)	1513AG
15" (375mm) x 10" (250mm)	1514AG
15" (375mm) x 12" (300mm)	1515AG
18" (450mm) x 4" (100mm)	1811AG
18" (450mm) x 6" (150mm)	1812AG
18" (450mm) x 8" (200mm)	1813AG
18" (450mm) x 10" (250mm)	1814AG
18" (450mm) x 12" (300mm)	1815AG
18" (450mm) x 15" (375mm)	1816AG
24" (600mm) x 4" (100mm)	2411AG
24" (600mm) x 6" (150mm)	2412AG
24" (600mm) x 8" (200mm)	2413AG
24" (600mm) x 10" (250mm)	2414AG
24" (600mm) x 12" (300mm)	2415AG
24" (600mm) x 15" (375mm)	2416AG
24" (600mm) x 18" (450mm)	2417AG

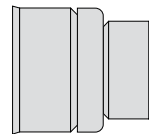

CONCENTRIC REDUCER

ELBOWS

ELBOW 22.5° WITH N-12 GASKETED BRANCH

SIZE	PRODUCT CODE
4" (100mm)	0422AG
6" (150mm)	0622AG
8" (200mm)	0822AG
10" (250mm)	1022AG
12" (300mm)	1222AG
15" (375mm)	1522AG
18" (450mm)	1822AG
24" (600mm)	2422AG

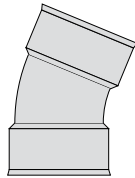

ELBOW 22.5°

ELBOW 90° WITH N-12 GASKETED BRANCH

SIZE	PRODUCT CODE
10" (250mm)	1090AG
12" (300mm)	1290AG
15" (375mm)	1590AG
18" (450mm)	1890AG
24" (600mm)	2490AG

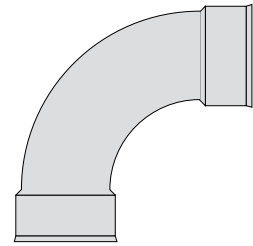

ELBOW 90°

ELBOW 45° WITH N-12 GASKETED BRANCH

SIZE	PRODUCT CODE
10" (250mm)	1045AG
12" (300mm)	1245AG
15" (375mm)	1545AG
18" (450mm)	1845AG
24" (600mm)	2445AG

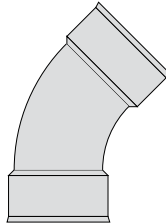

ELBOW 45°

END CAP

END CAP WITH N-12 GASKETED BRANCH

SIZE	PRODUCT CODE
4" (100mm)	0432AG
6" (150mm)	0632AG
8" (200mm)	0832AG
10" (250mm)	1032AG
12" (300mm)	1232AG
15" (375mm)	1532AG
18" (450mm)	1832AG
24" (600mm)	2432AG



END CAP

MANHOLE ADAPTER

SANDED MANHOLE ADAPTER

SIZE	PRODUCT CODE
4" (100mm)	0477AG
6" (150mm)	0677AG
8" (200mm)	0877AG
10" (250mm)	1077AG
12" (300mm)	1277AG
15" (375mm)	1577AG
18" (450mm)	1877AG
24" (600mm)	2477AG

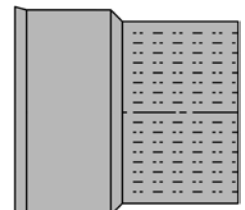

SANDED MANHOLE ADAPTER

CATCH BASINS

POLYETHYLENE CATCH BASINS* Custom made to order only

RISER DIAMETER	RISER HEIGHT	STUB** DIAMETER
12" - 36" (300mm-900mm)	2' - 8' (0.6m-2.4m)	4" - 30" (100mm-750mm)

*RISERS MUST BE PROPERLY BACKFILLED VERTICALLY PER DRAINAGE HANDBOOK - INSTALLATIONS/ VERTICAL. USE FITTING LIMITATION SHEET TO INFORM AND ENSURE PROPER INSTALLATION COMPLIANCE. 42" THROUGH 60" (1050 THROUGH 1500MM) HDPE NOT AVAILABLE FOR VERTICAL APPLICATIONS.

STUBS MUST FIT ON CIRCUMFERENCE AND HEIGHT OF RISER AND MUST NOT BE OVERLAPPING. STUBS ARE STANDARD LENGTH FOR COUPLING AND MUST BE A SMALLER DIAMETER THAN THE RISER. NO MORE THAN THREE STUBS PER STRUCTURE UNDER MOST CIRCUMSTANCES.

LIDS SHOULD BE INSTALLED PER LIGHT DUTY CATCH BASIN DETAIL AND ARE AVAILABLE THROUGH OTHER MANUFACTURERS. CATCH BASIN LIDS ARE NOT FABRICATED BY ADS/HANCOR. HDPE BOTTOM DOES NOT COME STANDARD WITH RISERS. MUST BE REQUESTED. **STUBS AVAILABLE IN N-12® (HUB), N-12® PLAIN END OR SMOOTH HDPE.

END CAPS ARE FOR HORIZONTAL APPLICATIONS ONLY. END CAPS ARE NOT PERMITTED TO BE USED IN ANY VERTICAL APPLICATIONS. MISUSE OR FAILURE TO PROPERLY SECURE END CAPS MAY RESULT IN DAMAGE TO PERSONS OR PROPERTY OR MAY RESULT IN INJURY OR DEATH.

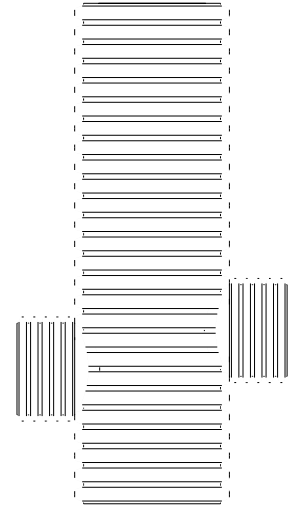

CATCH BASIN

HP MANHOLE FOR STORM DRAINAGE* Custom made to order only

RISER DIAMETER	RISER HEIGHT	STUB** DIAMETER
48" (1200mm)	2' - 8' (0.6m-2.4m)	4" - 30" (100mm-750mm)

*RISERS MUST BE PROPERLY BACKFILLED VERTICALLY PER DRAINAGE HANDBOOK - INSTALLATIONS/ VERTICAL. USE FITTING LIMITATION SHEET TO INFORM AND ENSURE PROPER INSTALLATION COMPLIANCE.

STUBS MUST FIT ON CIRCUMFERENCE AND HEIGHT OF RISER AND MUST NOT BE OVERLAPPING. STUBS ARE STANDARD LENGTH FOR COUPLING AND MUST BE A SMALLER DIAMETER THAN THE RISER. NO MORE THAN THREE STUBS PER STRUCTURE UNDER MOST CIRCUMSTANCES.

LIDS SHOULD BE INSTALLED PER LIGHT DUTY CATCH BASIN DETAIL AND ARE AVAILABLE THROUGH OTHER MANUFACTURERS. CATCH BASIN LIDS ARE NOT FABRICATED BY ADS/HANCOR. **STUBS AVAILABLE IN N-12® HP (HUB) OR N-12® HP PLAIN END.

END CAPS ARE FOR HORIZONTAL APPLICATIONS ONLY. END CAPS ARE NOT PERMITTED TO BE USED IN ANY VERTICAL APPLICATIONS. MISUSE OR FAILURE TO PROPERLY SECURE END CAPS MAY RESULT IN DAMAGE TO PERSONS OR PROPERTY OR MAY RESULT IN INJURY OR DEATH.



HP MANHOLE FOR STORM DRAINAGE

HICKENBOTTOM® RISERS

HICKENBOTTOM RISERS



SIZE	DESCRIPTION	PRODUCT CODE
5" (125mm) x 1" (25mm)	Orange Intake (12 Holes)	5013GC
5" (125mm) x 1" (25mm)	Orange Riser with Cap-Top	5023GC
5" (125mm) x 5/16" (8mm)	Orange Ext-Btm	5033GC
5" (125mm)	Blind Tee	5043GC
5" (125mm)	Restrictor	5063GC
6" (150mm) x 1" (25mm)	Orange Riser with Cap-Top	6023GC
6" (150mm) x 5/16" (8mm)	Orange Ext-Btm	6033GC
6" (150mm)	Black Slotted Intake	6073GC
6" (150mm)	Black Blank Section	6053GC
6" (150mm)	Black Riser Blind Tee	6043GC
6" (150mm)	Restrictor	6063GC
8" (200mm) x 1" (25mm)	Orange Riser with Cap-Top	0823GC
8" (200mm) x 5/16" (8mm)	Orange Ext-Btm	0833GC
8" (200mm)	Black Slotted Intake	0873GC
8" (200mm)	Black Blank Section	0853GC
8" (200mm)	Black Riser Blind Tee	0843GC
8" (200mm)	Restrictor	0863GC
10" (250mm) x 1" (25mm)	Orange Riser with Cap-Top	1023GC
10" (250mm) x 5/16" (8mm)	Orange Ext-Btm	1033GC
10" (250mm)	Black Slotted Intake	1073GC
10" (250mm)	Black Blank Section	1053GC
10" (250mm)	Black Riser Blind Tee	1043GC
12" (300mm) x 1" (25mm)	Orange Riser with Cap-Top	1223GC
12" (300mm) x 5/16" (8mm)	Orange Ext-Btm	1233GC
12" (300mm)	Black Slotted Intake	1273GC
12" (300mm)	Black Blind Tee	1243GC



HICKENBOTTOM RISER



HICKENBOTTOM RESTRICTOR



PRECISION INTAKES & RISERS

PRECISION INTAKES



SIZE	DESCRIPTION	PRODUCT CODE
6" x 1" (150 x 25 mm)	Yellow Riser with Cap-Top	6023GKY
6" x 5/16" (150 x 8 mm)	Yellow Ext-Btm	6033GKY
6" (150 mm)	Black Slotted Intake	6073GKY
6" (150 mm)	Black Blank Section	6053GKY
6" (150 mm)	Black Riser Blind Tee	6043GKY
6" (150 mm)	Restrictor	6063GKY
8" x 1" (200 x 25 mm)	Yellow Riser with Cap-Top	0823GKY
8" x 5/16" (200 x 8 mm)	Yellow Ext-Btm	0833GKY
8" (200 mm)	Black Slotted Intake	0873GKY
8" (200 mm)	Black Blank Section	0853GKY
8" (200 mm)	Black Riser Blind Tee	0843GKY
8" (200 mm)	Restrictor	0863GKY
10" x 1" (250 x 25 mm)	Yellow Riser with Cap-Top	1023GKY
10" x 5/16" (200 x 8 mm)	Yellow Ext-Btm	1033GKY
10" (250 mm)	Black Slotted Intake	1073GKY
10" (250 mm)	Black Blank Section	1053GKY
10" (250 mm)	Black Riser Blind Tee	1043GKY

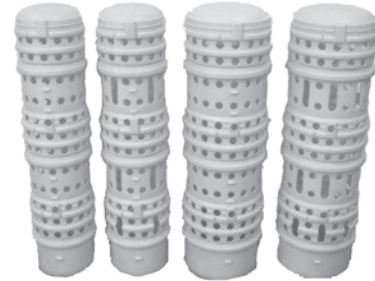

QUICK DRAIN RISERS



SIZE	PRODUCT CODE
6" Diameter x 6" Inlet (150 x 150 mm)	0606QD
10" Diameter x 6" Inlet (250 x 150 mm)	1006QD
10" Diameter x 8" Inlet (250 x 200 mm)	1008QD
6" Diameter x 6" Inlet (150 x 150 mm) with Adjustable Inlet	0606TPTQD



QUICK DRAIN RISER



ADJUSTABLE INLET

OUTFLOW ACCESSORIES

FLARED END SECTIONS, ANIMAL GUARDS & TRASH GUARDS

FLARED END SECTIONS



SIZE	PRODUCT CODE
10" (250mm)	1015NP
12" (300mm) / 15" (375mm)	1215NP
18" (450mm)	1810NP
24" (600mm)	2410NP
30" (750mm)	3015NP
36" (900mm)	3615NP

TOP VIEW

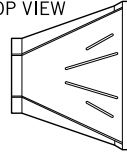

SIDE VIEW

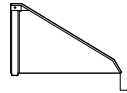

FRONT VIEW
STAINLESS STEEL
THREADED FASTENER

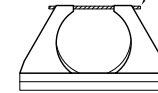

FLARED END SECTION

METAL TRASH GUARDS*



DIAMETER	DESCRIPTION	PRODUCT CODE
12" (300mm)	GALVANIZED STEEL	1290DA
15" (375mm)	GALVANIZED STEEL	1590DA
18" (450mm)	GALVANIZED STEEL	1890DA
24" (600mm)	GALVANIZED STEEL	2490DA
30" (750mm)	GALVANIZED STEEL	3090DA
36" (900mm)	GALVANIZED STEEL	3690DA

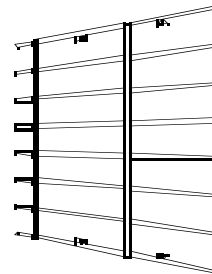

METAL TRASH GUARD

*Grate is sized to fit flared end sections only.

ANIMAL GUARDS



DIAMETER	DESCRIPTION	PRODUCT CODE
4" (100mm)	METAL ANIMAL GUARD (FINGER)	0470DA
	ANIMAL GUARD (SOLID)	0471DA
6" (150mm)	METAL ANIMAL GUARD (FINGER)	0670DA
	ANIMAL GUARD (SOLID)	0671DA
8" (200mm)	METAL ANIMAL GUARD (FINGER)	0870DA
	ANIMAL GUARD (SOLID)	0871DA
10" (250mm)	METAL ANIMAL GUARD (FINGER)	1070DA
	ANIMAL GUARD (SOLID)	1071DA
12" (300mm)	METAL ANIMAL GUARD (FINGER)	1270DA
15" (375mm)	METAL ANIMAL GUARD (FINGER)	1570DA
18" (450mm)	METAL ANIMAL GUARD (FINGER)	1870DA
24" (600mm)	METAL ANIMAL GUARD (FINGER)	2470DA
30" (750mm)	METAL ANIMAL GUARD (FINGER)	3070DA
36" (900mm)	METAL ANIMAL GUARD (FINGER)	3670DA

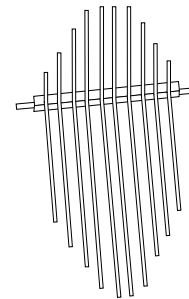

ANIMAL GUARD
(FINGER)

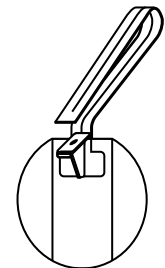

ANIMAL GUARD
(SOLID)

OUTFLOW ACCESSORIES

BAR GUARDS & FLAP GATES

BAR GUARDS



DIAMETER	PRODUCT CODE
4" (100mm)	0420DA
6" (150mm)	0620DA
8" (200mm)	0820DA
10" (250mm)	1020DA
12" (300mm)	1220DA
15" (375mm)	1520DA
18" (450mm)	1820DA
24" (600mm)	2420DA
30" (750mm)	3020DA
36" (900mm)	3620DA



BAR GUARD

FLAP GATES



DIAMETER	PRODUCT CODE
4" (100mm)	0440DA
6" (150mm)	0640DA
8" (200mm)	0840DA
10" (250mm)	1040DA
12" (300mm)	1240DA
15" (375mm)	1540DA
18" (450mm)	1840DA
24" (600mm)	2440DA
30" (750mm)	3040DA
36" (900mm)	3640DA



FLAP GATE

RETENTION/DETENTION SYSTEMS

LANDMAX®

MANIFOLDS – SIZE ON SIZE STUBS

PIPE SIZE	N-12 PLAIN END COMPONENT MANIFOLD – SIZE ON SIZE		
	SINGLE	DOUBLE	TRIPLE
12" (300mm)	1251AN	1252AN	1253AN
15" (375mm)	1551AN	1552AN	1553AN
18" (450mm)	1851AN	1852AN	1853AN
24" (600mm)	2451AN	2452AN	2453AN
30" (750mm)	3051AN	3052AN	3053AN
36" (900mm)	3651AN	3652AN	3653AN
42" (1050mm)	4251AN	4252AN	
48" (1200mm)	4851AN	4852AN	
60" (1500mm)	6051AN	6052AN	

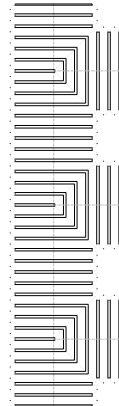
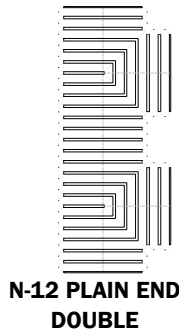
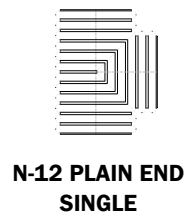

90° BEND MANIFOLDS

PIPE SIZE	N-12 PLAIN END	N-12 (WT) BELL x BELL	N-12 (WT) GASKET x GASKET	N-12 (WT) BELL x GASKET
12" (300mm)	1298AN	1298AN65BB	1298AN65GG	1298AN65BBG
15" (375mm)	1598AN	1598AN65BB	1598AN65GG	1598AN65BBG
18" (450mm)	1898AN	1898AN65BB	1898AN65GG	1898AN65BBG
24" (600mm)	2498AN	2498AN65BB	2498AN65GG	2498AN65BBG
30" (750mm)	3098AN	3098AN65BB	3098AN65GG	3098AN65BBG
36" (900mm)	3698AN	3698AN65BB	3698AN65GG	3698AN65BBG
42" (1050mm)	4298AN	4298AN65BB	4298AN65GG	4298AN65BBG
48" (1200mm)	4898AN	4898AN65BB	4898AN65GG	4898AN65BBG
60" (1500mm)	6098AN	6098AN65BB	6098AN65GG	6098AN65BBG

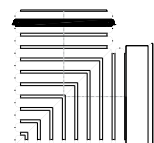
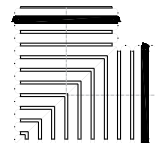
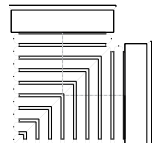
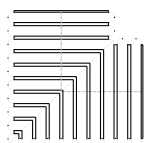

NOTE: CONTACT YOUR LOCAL SALES REPRESENTATIVE FOR AVAILABILITY OF SIZES NOT LISTED ABOVE. *FOR RETENTION SYSTEMS ONLY.

RETENTION/DETENTION SYSTEMS

LANDMAX®

MANIFOLDS – SIZE ON SIZE STUBS

PIPE SIZE	N-12 (WT) BELL END COMPONENT MANIFOLD – SIZE ON SIZE			N-12 (WT) GASKET END COMPONENT MANIFOLD – SIZE ON SIZE		
	SINGLE	DOUBLE	TRIPLE	SINGLE	DOUBLE	TRIPLE
12" (300mm)	1251AN65B	1252AN65B	1253AN65B	1251AN65G	1252AN65G	1253AN65G
15" (375mm)	1551AN65B	1552AN65B	1553AN65B	1551AN65G	1552AN65G	1553AN65G
18" (450mm)	1851AN65B	1852AN65B	1853AN65B	1851AN65G	1852AN65G	1853AN65G
24" (600mm)	2451AN65B	2452AN65B	2453AN65B	2451AN65G	2452AN65G	2453AN65G
30" (750mm)	3051AN65B	3052AN65B	3053AN65B	3051AN65G	3052AN65G	3053AN65G
36" (900mm)	3651AN65B	3652AN65B	3653AN65B	3651AN65G	3652AN65G	3653AN65G
42" (1050mm)	4251AN65B	4252AN65B		4251AN65G	4252AN65G	
48" (1200mm)	4851AN65B	4852AN65B		4851AN65G	4852AN65G	
60" (1500mm)	6051AN65B	6052AN65B		6051AN65G	6052AN65G	

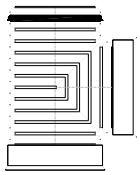

N-12 WT
BELL END
SINGLE

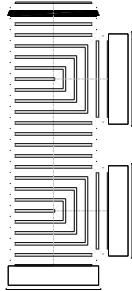

N-12 WT
BELL END
DOUBLE

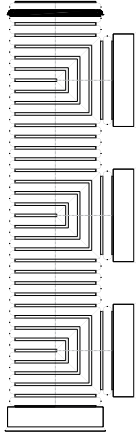

N-12 WT
BELL END
TRIPLE

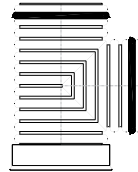

N-12 WT
GASKET END
SINGLE

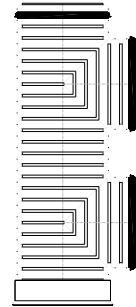

N-12 WT
GASKET END
DOUBLE

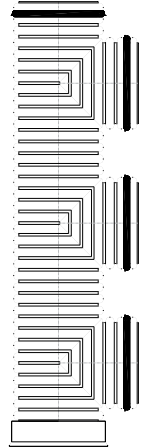

N-12 WT
GASKET END
TRIPLE

NOTE: CONTACT YOUR LOCAL SALES REPRESENTATIVE FOR AVAILABILITY OF SIZES NOT LISTED ABOVE.
*FOR RETENTION SYSTEMS ONLY.

RETENTION/DETENTION SYSTEMS

LANDMAX® ACCESSORIES

DUAL WALL FABRICATED MANIFOLD INLET RISER

PIPE SIZE	PRODUCT CODE
4" (100mm)	0403AN
6" (150mm)	0603AN
8" (200mm)	0803AN
10" (250mm)	1003AN
12" (300mm)	1203AN
15" (375mm)	1503AN
18" (450mm)	1803AN
24" (600mm)	2403AN

This component item can only be ordered with standard manifold fittings or standard pipe. When ordering this component item, be sure to include shop drawing showing the location of inlet riser on standard manifold or pipe product.

Contact your local sales representative for acceptable size combinations, i.e.: 48" manifold fitting with a 24" diameter riser. **Not all combinations of inlet riser on standard manifold or pipe product are allowed.**

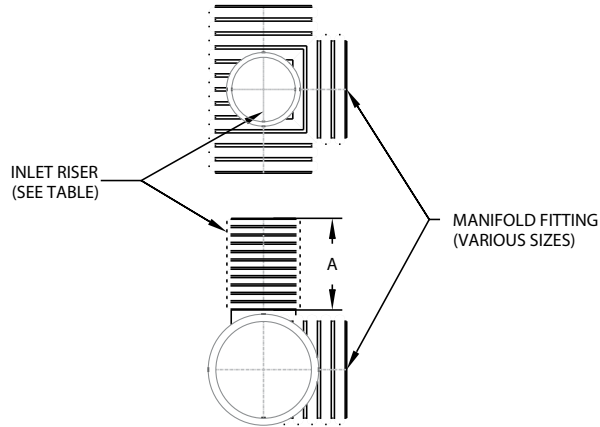

DUAL WALL FABRICATED MANIFOLD CLEANOUT RISER

PIPE SIZE	PRODUCT CODE
4" (100mm)	0402AN
6" (150mm)	0602AN
8" (200mm)	0802AN

This component item can only be ordered with standard manifold fittings. When ordering this component item, be sure to include shop drawing showing the location of inlet riser on standard manifold.

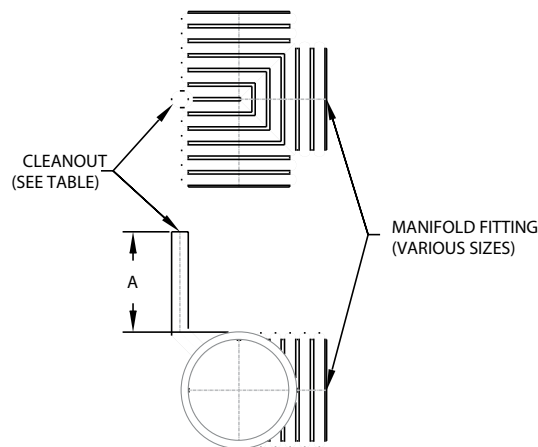

RETENTION/DETENTION SYSTEMS

LANDMAX® ACCESSORIES*

WELDED END PLATES (ST/WT CONNECTION)

PIPE SIZE	PRODUCT CODE
4" (100mm)	0409AN
6" (150mm)	0609AN
8" (200mm)	0809AN
10" (250mm)	1009AN
12" (300mm)	1209AN
15" (375mm)	1509AN
18" (450mm)	1809AN
24" (600mm)	2409AN
30" (750mm)	3009AN
36" (900mm)	3609AN
42" (1050mm)	4209AN
48" (1200mm)	4809AN
60" (1500mm)	6009AN

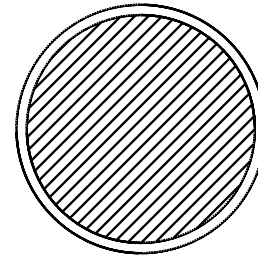
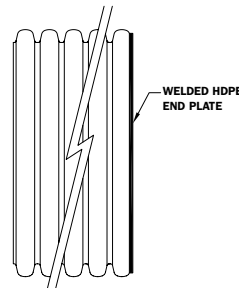

TOP VIEW
WELDED END PLATE

DUAL WALL FABRICATED STUB

DIAMETER	PRODUCT CODE
4" (100mm)	0406AN
6" (150mm)	0606AN
8" (200mm)	0806AN
10" (250mm)	1006AN
12" (300mm)	1206AN
15" (375mm)	1506AN
18" (450mm)	1806AN
24" (600mm)	2406AN

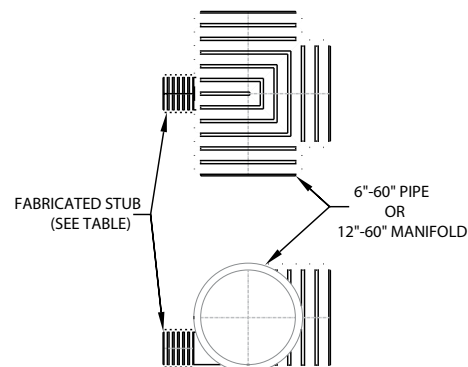

This component item can only be ordered with standard manifold fittings or standard pipe. When ordering this component item, be sure to include shop drawing showing the location of stub on standard manifold or pipe product.

Contact your local sales representative for acceptable size combinations, i.e.: 48" manifold fitting with a 24" stub. **Not all combinations of stub on standard manifold or pipe product are allowed.**

RETENTION/DETENTION

STORMTECH®

SC-160

DIMENSIONS L x W x H	NOMINAL WEIGHT	STORAGE CAPACITY	MIN. INSTALLED STORAGE	PRODUCT CODE
85.4" (2169mm) x 25" (635mm) x 12" (305mm)	24 lbs. (10.9kg)	6.85 ft ³ (0.19m ³)	15.0 ft ³ (0.42m ³)	SC160

SC-310

DIMENSIONS L x W x H	NOMINAL WEIGHT	STORAGE CAPACITY	MIN. INSTALLED STORAGE	PRODUCT CODE
85.4" (2169mm) x 34" (864mm) x 16" (406mm)	35 lbs. (15.9kg)	14.7 ft ³ (0.42m ³)	31.0 ft ³ (0.88m ³)	SC310

SC-740

DIMENSIONS L x W x H	NOMINAL WEIGHT	STORAGE CAPACITY	MIN. INSTALLED STORAGE	PRODUCT CODE
85.4" (2169mm) x 51" (1295mm) x 30" (762mm)	75 lbs. (34.1kg)	45.9 ft ³ (1.30m ³)	74.9 ft ³ (2.12m ³)	SC740

DC-780

DIMENSIONS L x W x H	NOMINAL WEIGHT	STORAGE CAPACITY	MIN. INSTALLED STORAGE	PRODUCT CODE
85.4" (2169mm) x 51" (1295mm) x 30" (762mm)	80 lbs. (36.3kg)	46.2 ft ³ (1.30m ³)	78.4 ft ³ (2.20m ³)	DC780

MC-3500

DIMENSIONS L x W x H	NOMINAL WEIGHT	STORAGE CAPACITY	MIN. INSTALLED STORAGE	PRODUCT CODE
86.0" (2184mm) x 77" (1956mm) x 45" (1143mm)	135 lbs. (61.2kg)	109.9 ft ³ (3.11m ³)	178.9 ft ³ (5.06m ³)	MC3500

MC-4500

DIMENSIONS L x W x H	NOMINAL WEIGHT	STORAGE CAPACITY	MIN. INSTALLED STORAGE	PRODUCT CODE
52" (1321mm) x 100" (2540mm) x 60" (1524mm)	130 lbs. (59.0kg)	106.5 ft ³ (3.01m ³)	162.6 ft ³ (4.60m ³)	MC4500



MC-4500

MC-3500

DC-780

SC-740

SC-310

SC-160LP

RETENTION/DETENTION

STORMTECH ENDCAPS

SC-160LP

DIMENSIONS L x W x H	NOMINAL WEIGHT	PRODUCT CODE
4.4" (112mm) x 18.6" (472mm) x 11.7" (297mm)	2 lbs. (0.6kg)	SC160IEPP

SC-310

DIMENSIONS L x W x H	NOMINAL WEIGHT	PRODUCT CODE
9.9" (252mm) x 29" (737mm) x 15.6" (396 mm)	4 lbs. (1.8kg)	SC310EPE

SC-740

DIMENSIONS L x W x H	NOMINAL WEIGHT	PRODUCT CODE
12.2 (310mm) x 45.9" (1166mm) x 29.3" (744 mm)	13 lbs. (5.9kg)	SC740EPE

DC-780

DIMENSIONS L x W x H	NOMINAL WEIGHT	PRODUCT CODE
12.2 (310mm) x 45.9" (1166mm) x 29.3" (744mm)	13 lbs. (5.9kg)	SC740EPE

MC-3500

DIMENSIONS L x W x H	NOMINAL WEIGHT	STORAGE CAPACITY	MIN. INSTALLED STORAGE*	PRODUCT CODE
25.7" (653mm) x 77" (1956mm) x 45.0" (1143 mm)	50 lbs. (22.7kg)	14.9 ft ³ (0.42m ³)	46.0 ft ³ (1.30m ³)	MC3500IEPP

MC-4500

DIMENSIONS L x W x H	NOMINAL WEIGHT	STORAGE CAPACITY	MIN. INSTALLED STORAGE*	PRODUCT CODE
35.1" (892mm) x 90.2" (2291mm) x 59.4" (1509mm)	135 lbs. (61.2kg)	35.7 ft ³ (1.01m ³)	108.7 ft ³ (3.08m ³)	MC4500REPE

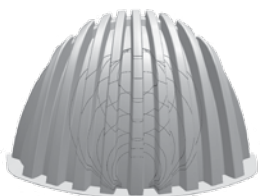

MC-4500 END CAP

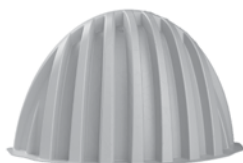

MC-3500 END CAP



DC-780 END CAP

SC-310, SC-740
END CAPS

SC-160LP END CAP

RETENTION/DETENTION

STORMTECH ENDCAPS/ACCESSORIES

TOP INLET FABRICATED END CAPS

TYPE	DIAMETER	PRODUCT CODE
SC-310	6" (150mm) HDPE	SC310EPE06T
SC-740/ DC-780	6" (150mm) HDPE	SC740EPE06T
	12" (300mm) HDPE	SC740EPE12T
	15" (375mm) HDPE	SC740EPE15T
	18" (450mm) HDPE	SC740EPE18T
MC-3500	6" (150mm) HDPE	MC3500IEPP06T
	8" (200mm) HDPE	MC3500IEPP08T
	10" (250mm) HDPE	MC3500IEPP10T
	12" (300mm) HDPE	MC3500IEPP12T
	15" (375mm) HDPE	MC3500IEPP15T
	18" (450mm) HDPE	MC3500IEPP18T
MC-4500	24" (600mm) HDPE	MC3500IEPP24T
	12" (300mm) HDPE	MC4500REPE12T
	15" (375mm) HDPE	MC4500REPE15T
	18" (450mm) HDPE	MC4500REPE18T
	24" (600mm) HDPE	MC4500REPE24T



**TOP INLET
FABRICATED ENDCAP**

BOTTOM INLET FABRICATED END CAPS

TYPE	DIAMETER	PRODUCT CODE
SC-310	6" (150mm) HDPE	SC310EPE06B
	8" (200mm) HDPE	SC310EPE08B
	10" (250mm) HDPE	SC310EPE10B
	12" (300mm) HDPE	SC310EPE12B
SC-740/ DC-780	6" (150mm) HDPE	SC740EPE06B
	8" (200mm) HDPE	SC740EPE08B
	10" (300mm) HDPE	SC740EPE10B
	12" (300mm) HDPE	SC740EPE12B
	15" (375mm) HDPE	SC740EPE15B
	18" (450mm) HDPE	SC740EPE18B
MC-3500	24" (600mm) HDPE	SC740EPE24B
	6" (150mm) HDPE	MC3500IEPP06B
	8" (200mm) HDPE	MC3500IEPP08B
	10" (250mm) HDPE	MC3500IEPP10B
	12" (300mm) HDPE	MC3500IEPP12B
	15" (375mm) HDPE	MC3500IEPP15B
	18" (450mm) HDPE	MC3500IEPP18B
MC-4500	24" (600mm) HDPE	MC3500IEPP24B
	30" (750mm) HDPE	MC3500IEPP30B
	12" (300mm) HDPE	MC4500REPE12B
	15" (250mm) HDPE	MC4500REPE15B
	18" (300mm) HDPE	MC4500REPE18B
	24" (375mm) HDPE	MC4500REPE24B
	30" (450mm) HDPE	MC4500REPE30B
	36" (600mm) HDPE	MC4500REPE36B
42" (750mm) HDPE	MC4500REPE42B	



**BOTTOM INLET
FABRICATED ENDCAP**

RETENTION/DETENTION

STORMTECH ACCESSORIES 90° BENDS

SC-310 BENDS

DESCRIPTION	PRODUCT CODE
6" (150mm)	0698AN31
8" (200mm)	0898AN31
10" (250mm)	1098AN31
12" (300mm)	1298AN31

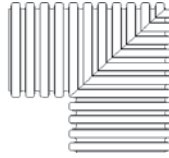

BEND

SC-740/DC-780 BENDS

DESCRIPTION	PRODUCT CODE
8" (200mm)	0898AN74
10" (250mm)	1098AN74
12" (300mm)	1298AN74
15" (375mm)	1598AN74
18" (450mm)	1898AN74
24" (600mm)	2498AN74

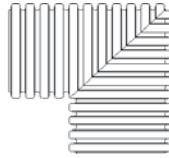

BEND

MC-3500 BENDS

DESCRIPTION	PRODUCT CODE
12" (300mm)	1298AN3512
15" (375mm)	1598AN3515
18" (450mm)	1898AN3518
24" (600mm)	2498AN3524

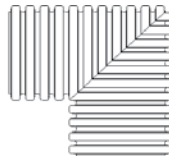

BEND

MC-4500 BENDS

DESCRIPTION	PRODUCT CODE
12" (300mm)	1298AN4512
15" (375mm)	1598AN4515
18" (450mm)	1898AN4518
24" (600mm)	2498AN4524

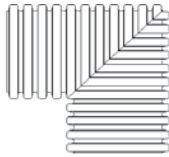

BEND

RETENTION/DETENTION

STORMTECH ACCESSORIES*

SC-310 SINGLE MANIFOLDS SIZE ON SIZE

DESCRIPTION	PRODUCT CODE
6" x 6" (150mm x 150mm) Tee	0651AN3106
8" x 8" (200mm x 200mm) Tee	0851AN3108
10" x 10" (250mm x 250mm) Tee	1051AN3110
12" x 12" (300mm x 300mm) Tee	1251AN3112

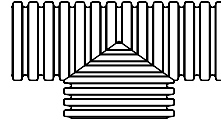

SINGLE MANIFOLD

SC-740/DC-780 SINGLE MANIFOLDS SIZE ON SIZE

DESCRIPTION	PRODUCT CODE
6" x 6" (150mm x 150mm) Tee	0651AN7406
8" x 8" (200mm x 200mm) Tee	0851AN7408
10" x 10" (250mm x 250mm) Tee	1051AN7410
12" x 12" (300mm x 300mm) Tee	1251AN7412
15" x 15" (375mm x 375mm) Tee	1551AN7415
18" x 18" (450mm x 450mm) Tee	1851AN7418
24" x 24" (600mm x 600mm) Tee	2451AN7424

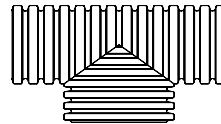

SINGLE MANIFOLD

MC-3500 SINGLE MANIFOLDS SIZE ON SIZE

DESCRIPTION	PRODUCT CODE
12" x 12" (300mm x 300mm) Tee	1251AN3512
15" x 15" (375mm x 375mm) Tee	1551AN3515
18" x 18" (450mm x 450mm) Tee	1851AN3518
24" x 24" (600mm x 600mm) Tee	2451AN3524

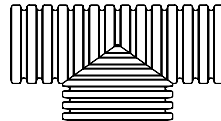

SINGLE MANIFOLD

MC-4500 SINGLE MANIFOLDS SIZE ON SIZE

DESCRIPTION	PRODUCT CODE
12" x 12" (300mm x 300mm) Tee	1251AN4512
15" x 15" (375mm x 375mm) Tee	1551AN4515
18" x 18" (450mm x 450mm) Tee	1851AN4518
24" x 24" (600mm x 600mm) Tee	2451AN4524

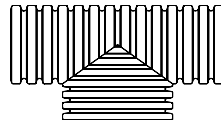

SINGLE MANIFOLD

RETENTION/DETENTION

STORMTECH ACCESSORIES*

SC-310 DOUBLE MANIFOLDS SIZE ON SIZE

DESCRIPTION	PRODUCT CODE
6" x 6" (150mm x 150mm) Tee	0652AN3106
8" x 8" (200mm x 200mm) Tee	0852AN3108
10" x 10" (250mm x 250mm) Tee	1052AN3110
12" x 12" (300mm x 300mm) Tee	1252AN3112

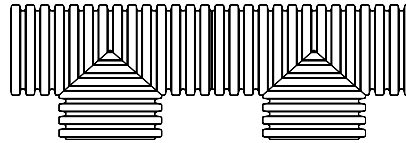

DOUBLE MANIFOLD

SC-740/DC-780 DOUBLE MANIFOLDS SIZE ON SIZE

DESCRIPTION	PRODUCT CODE
6" x 6" (150mm x 150mm) Tee	0652AN7406
8" x 8" (200mm x 200mm) Tee	0852AN7408
10" x 10" (250mm x 250mm) Tee	1052AN7410
12" x 12" (300mm x 300mm) Tee	1252AN7412
15" x 15" (375mm x 375mm) Tee	1552AN7415
18" x 18" (450mm x 450mm) Tee	1852AN7418
24" x 24" (600mm x 600mm) Tee	2452AN7424

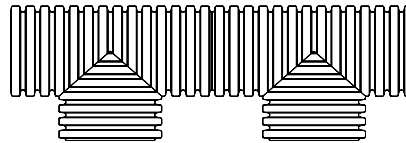

DOUBLE MANIFOLD

MC-3500 DOUBLE MANIFOLDS SIZE ON SIZE

DESCRIPTION	PRODUCT CODE
12" x 12" (300mm x 300mm) Tee	1252AN3512
15" x 15" (375mm x 375mm) Tee	1552AN3515
18" x 18" (450mm x 450mm) Tee	1852AN3518
24" x 24" (600mm x 600mm) Tee	2452AN3524

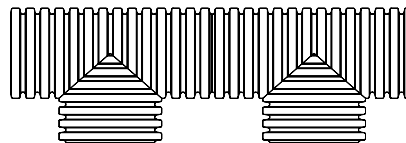

DOUBLE MANIFOLD

SC-310 TRIPLE MANIFOLDS SIZE ON SIZE

DESCRIPTION	PRODUCT CODE
6" x 6" (150mm x 150mm) Tee	0653AN3106
8" x 8" (200mm x 200mm) Tee	0853AN3108
10" x 10" (250mm x 250mm) Tee	1053AN3110
12" x 12" (300mm x 300mm) Tee	1253AN3112

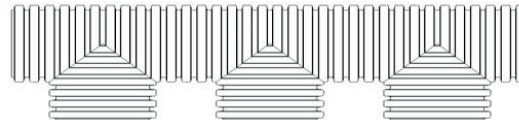

TRIPLE MANIFOLD

SC-740/DC-780 TRIPLE MANIFOLDS SIZE ON SIZE

DESCRIPTION	PRODUCT CODE
6" x 6" (150mm x 150mm) Tee	0653AN7406
8" x 8" (200mm x 200mm) Tee	0853AN7408
10" x 10" (250mm x 250mm) Tee	1053AN7410
12" x 12" (300mm x 300mm) Tee	1253AN7412
15" x 15" (375mm x 375mm) Tee	1553AN7415
18" x 18" (450mm x 450mm) Tee	1853AN7418
24" x 24" (600mm x 600mm) Tee	2453AN7424

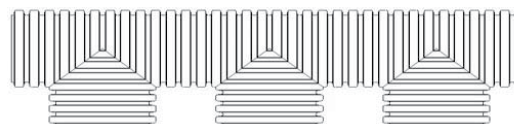

TRIPLE MANIFOLD

*ADDITIONAL ACCESSORIES CAN BE FOUND ON PAGES 29-30.

RETENTION/DETENTION

STORMTECH ACCESSORIES*

SC-310 SINGLE MANIFOLDS REDUCING

DESCRIPTION	PRODUCT CODE
8" x 6" (200mm x 150mm) Tee	0851AN3106
10" x 6" (250mm x 150mm) Tee	1051AN3106
10" x 8" (250mm x 200mm) Tee	1051AN3108
12" x 6" (300mm x 150mm) Tee	1251AN3106
12" x 8" (300mm x 200mm) Tee	1251AN3108
12" x 10" (300mm x 250mm) Tee	1251AN3110
15" x 6" (375mm x 150mm) Tee	1551AN3106
15" x 8" (375mm x 200mm) Tee	1551AN3108
15" x 10" (375mm x 250mm) Tee	1551AN3110
15" x 12" (375mm x 300mm) Tee	1551AN3112
18" x 6" (450mm x 150mm) Tee	1851AN3106
18" x 8" (450mm x 200mm) Tee	1851AN3108
18" x 10" (450mm x 250mm) Tee	1851AN3110
18" x 12" (450mm x 300mm) Tee	1851AN3112
24" x 6" (600mm x 150mm) Tee	2451AN3106
24" x 8" (600mm x 200mm) Tee	2451AN3108
24" x 10" (600mm x 250mm) Tee	2451AN3110
24" x 12" (600mm x 300mm) Tee	2451AN3112

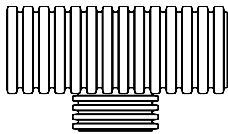

SINGLE MANIFOLD REDUCING**

SC-740/DC-780 SINGLE MANIFOLDS REDUCING

DESCRIPTION	PRODUCT CODE
8" x 6" (200mm x 150mm) Tee	0851AN7406
10" x 6" (250mm x 150mm) Tee	1051AN7406
10" x 8" (250mm x 200mm) Tee	1051AN7408
12" x 6" (300mm x 150mm) Tee	1251AN7406
12" x 8" (300mm x 200mm) Tee	1251AN7408
12" x 10" (300mm x 250mm) Tee	1251AN7410
15" x 6" (375mm x 150mm) Tee	1551AN7406
15" x 8" (375mm x 200mm) Tee	1551AN7408
15" x 10" (375mm x 250mm) Tee	1551AN7410
15" x 12" (375mm x 300mm) Tee	1551AN7412
18" x 6" (450mm x 150mm) Tee	1851AN7406
18" x 8" (450mm x 200mm) Tee	1851AN7408
18" x 10" (450mm x 250mm) Tee	1851AN7410
18" x 12" (450mm x 300mm) Tee	1851AN7412
18" x 15" (450mm x 375mm) Tee	1851AN7415
24" x 6" (600mm x 150mm) Tee	2451AN7406
24" x 8" (600mm x 200mm) Tee	2451AN7408
24" x 10" (600mm x 250mm) Tee	2451AN7410
24" x 12" (600mm x 300mm) Tee	2451AN7412
24" x 15" (600mm x 375mm) Tee	2451AN7415
24" x 18" (600mm x 450mm) Tee	2451AN7418
30" x 6" (750mm x 150mm) Tee	3051AN7406
30" x 12" (750mm x 300mm) Tee	3051AN7412
30" x 15" (750mm x 375mm) Tee	3051AN7415
30" x 18" (750mm x 450mm) Tee	3051AN7418
30" x 24" (750mm x 600mm) Tee	3051AN7424
36" x 12" (900mm x 300mm) Tee	3651AN7412
36" x 15" (900mm x 375mm) Tee	3651AN7415
36" x 18" (900mm x 450mm) Tee	3651AN7418
36" x 24" (900mm x 600mm) Tee	3651AN7424
42" x 12" (1050mm x 300mm) Tee	4251AN7412
42" x 15" (1050mm x 375mm) Tee	4251AN7415
42" x 18" (1050mm x 450mm) Tee	4251AN7418
42" x 24" (1050mm x 600mm) Tee	4251AN7424
48" x 12" (1200mm x 300mm) Tee	4851AN7412
48" x 15" (1200mm x 375mm) Tee	4851AN7415
48" x 18" (1200mm x 450mm) Tee	4851AN7418
48" x 24" (1200mm x 600mm) Tee	4851AN7424

*ADDITIONAL ACCESSORIES CAN BE FOUND ON PAGES 29-30.

**ALL STORMTECH REDUCING MANIFOLDS ARE ECCENTRIC.

RETENTION/DETENTION

STORMTECH ACCESSORIES*

MC-3500 SINGLE MANIFOLDS REDUCING

DESCRIPTION	PRODUCT CODE
15" x 12" (375mm x 300mm) Tee	1551AN3512
18" x 12" (450mm x 300mm) Tee	1851AN3512
18" x 15" (450mm x 375mm) Tee	1851AN3515
24" x 12" (600mm x 300mm) Tee	2451AN3512
24" x 15" (600mm x 375mm) Tee	2451AN3515
24" x 18" (600mm x 450mm) Tee	2451AN3518
30" x 12" (750mm x 300mm) Tee	3051AN3512
30" x 15" (750mm x 375mm) Tee	3051AN3515
30" x 18" (750mm x 450mm) Tee	3051AN3518
30" x 24" (750mm x 600mm) Tee	3051AN3524
36" x 12" (750mm x 300mm) Tee	3651AN3512
36" x 15" (750mm x 375mm) Tee	3651AN3515
36" x 18" (750mm x 450mm) Tee	3651AN3518
36" x 24" (750mm x 600mm) Tee	3651AN3524
42" x 12" (750mm x 300mm) Tee	4251AN3512
42" x 15" (750mm x 375mm) Tee	4251AN3515
42" x 18" (750mm x 450mm) Tee	4251AN3518
42" x 24" (750mm x 600mm) Tee	4251AN3524
48" x 12" (1200mm x 300mm) Tee	4851AN3512
48" x 15" (1200mm x 375mm) Tee	4851AN3515
48" x 18" (1200mm x 450mm) Tee	4851AN3518
48" x 24" (1200mm x 600mm) Tee	4851AN3524

MC-4500 SINGLE MANIFOLDS REDUCING

DESCRIPTION	PRODUCT CODE
15" x 12" (375mm x 300mm) Tee	1551AN4512
18" x 12" (450mm x 300mm) Tee	1851AN4512
18" x 15" (450mm x 375mm) Tee	1851AN4515
24" x 12" (600mm x 300mm) Tee	2451AN4512
24" x 15" (600mm x 375mm) Tee	2451AN4515
24" x 18" (600mm x 450mm) Tee	2451AN4518
30" x 12" (750mm x 300mm) Tee	3051AN4512
30" x 15" (750mm x 375mm) Tee	3051AN4515
30" x 18" (750mm x 450mm) Tee	3051AN4518
30" x 24" (750mm x 600mm) Tee	3051AN4524
36" x 12" (750mm x 300mm) Tee	3651AN4512
36" x 15" (750mm x 375mm) Tee	3651AN4515
36" x 18" (750mm x 450mm) Tee	3651AN4518
36" x 24" (750mm x 600mm) Tee	3651AN4524
42" x 12" (750mm x 300mm) Tee	4251AN4512
42" x 15" (750mm x 375mm) Tee	4251AN4515
42" x 18" (750mm x 450mm) Tee	4251AN4518
42" x 24" (750mm x 600mm) Tee	4251AN4524
48" x 12" (1200mm x 300mm) Tee	4851AN4512
48" x 15" (1200mm x 375mm) Tee	4851AN4515
48" x 18" (1200mm x 450mm) Tee	4851AN4518
48" x 24" (1200mm x 600mm) Tee	4851AN4524

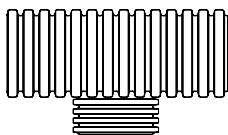

SINGLE MANIFOLD REDUCING**

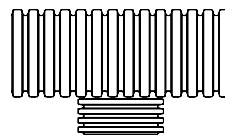

SINGLE MANIFOLD REDUCING**

*ADDITIONAL ACCESSORIES CAN BE FOUND ON PAGES 29-30.

**ALL STORMTECH REDUCING MANIFOLDS ARE ECCENTRIC.

RETENTION/DETENTION

STORMTECH ACCESSORIES*

SC-310 DOUBLE MANIFOLDS REDUCING

DESCRIPTION	PRODUCT CODE
8" x 6" (200mm x 150mm) Tee	0852AN3106
10" x 6" (250mm x 150mm) Tee	1052AN3106
10" x 8" (250mm x 200mm) Tee	1052AN3108
12" x 6" (300mm x 150mm) Tee	1252AN3106
12" x 8" (300mm x 200mm) Tee	1252AN3108
12" x 10" (300mm x 250mm) Tee	1252AN3110
15" x 6" (375mm x 150mm) Tee	1552AN3106
15" x 8" (375mm x 200mm) Tee	1552AN3108
15" x 10" (375mm x 250mm) Tee	1552AN3110
15" x 12" (375mm x 300mm) Tee	1552AN3112
18" x 6" (450mm x 150mm) Tee	1852AN3106
18" x 8" (450mm x 200mm) Tee	1852AN3108
18" x 10" (450mm x 250mm) Tee	1852AN3110
18" x 12" (450mm x 300mm) Tee	1852AN3112
24" x 6" (600mm x 150mm) Tee	2452AN3106
24" x 8" (600mm x 200mm) Tee	2452AN3108
24" x 10" (600mm x 250mm) Tee	2452AN3110
24" x 12" (600mm x 300mm) Tee	2452AN3112

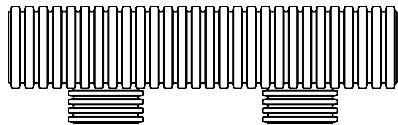

DOUBLE MANIFOLD REDUCING**

SC-740/DC-780 DOUBLE MANIFOLDS REDUCING

DESCRIPTION	PRODUCT CODE
8" x 6" (200mm x 150mm) Tee	0852AN7406
10" x 6" (250mm x 150mm) Tee	1052AN7406
10" x 8" (250mm x 200mm) Tee	1052AN7408
12" x 6" (300mm x 150mm) Tee	1252AN7406
12" x 8" (300mm x 200mm) Tee	1252AN7408
12" x 10" (300mm x 250mm) Tee	1252AN7410
15" x 6" (375mm x 150mm) Tee	1552AN7406
15" x 8" (375mm x 200mm) Tee	1552AN7408
15" x 10" (375mm x 250mm) Tee	1552AN7410
15" x 12" (375mm x 300mm) Tee	1552AN7412
18" x 6" (450mm x 150mm) Tee	1852AN7406
18" x 8" (450mm x 200mm) Tee	1852AN7408
18" x 10" (450mm x 250mm) Tee	1852AN7410
18" x 12" (450mm x 300mm) Tee	1852AN7412
18" x 15" (450mm x 375mm) Tee	1852AN7415
24" x 6" (600mm x 150mm) Tee	2452AN7406
24" x 8" (600mm x 200mm) Tee	2452AN7408
24" x 10" (600mm x 250mm) Tee	2452AN7410
24" x 12" (600mm x 300mm) Tee	2452AN7412
24" x 15" (600mm x 375mm) Tee	2452AN7415
24" x 18" (600mm x 450mm) Tee	2452AN7418
30" x 6" (750mm x 150mm) Tee	3052AN7406
30" x 12" (750mm x 300mm) Tee	3052AN7412
30" x 15" (750mm x 375mm) Tee	3052AN7415
30" x 18" (750mm x 450mm) Tee	3052AN7418
30" x 24" (750mm x 600mm) Tee	3052AN7424
36" x 12" (900mm x 300mm) Tee	3652AN7412
36" x 15" (900mm x 375mm) Tee	3652AN7415
36" x 18" (900mm x 450mm) Tee	3652AN7418
36" x 24" (900mm x 600mm) Tee	3652AN7424
42" x 12" (1050mm x 300mm) Tee	4252AN7412
42" x 15" (1050mm x 375mm) Tee	4252AN7415
42" x 18" (1050mm x 450mm) Tee	4252AN7418
42" x 24" (1050mm x 600mm) Tee	4252AN7424
48" x 12" (1200mm x 300mm) Tee	4852AN7412
48" x 15" (1200mm x 375mm) Tee	4852AN7415
48" x 18" (1200mm x 450mm) Tee	4852AN7418
48" x 24" (1200mm x 600mm) Tee	4852AN7424

*ADDITIONAL ACCESSORIES CAN BE FOUND ON PAGES 29-30.

**ALL STORMTECH REDUCING MANIFOLDS ARE ECCENTRIC.

RETENTION/DETENTION

STORMTECH ACCESSORIES*

MC-3500 DOUBLE MANIFOLDS REDUCING

DESCRIPTION	PRODUCT CODE
15" x 12" (375mm x 300mm) Tee	1552AN3512
18" x 12" (450mm x 300mm) Tee	1852AN3512
18" x 15" (450mm x 375mm) Tee	1852AN3515
24" x 12" (600mm x 300mm) Tee	2452AN3512
24" x 15" (600mm x 375mm) Tee	2452AN3515
24" x 18" (600mm x 450mm) Tee	2452AN3518
30" x 12" (750mm x 300mm) Tee	3052AN3512
30" x 15" (750mm x 375mm) Tee	3052AN3515
30" x 18" (750mm x 450mm) Tee	3052AN3518
30" x 24" (750mm x 600mm) Tee	3052AN3524
36" x 12" (750mm x 300mm) Tee	3652AN3512
36" x 15" (750mm x 375mm) Tee	3652AN3515
36" x 18" (750mm x 450mm) Tee	3652AN3518
36" x 24" (750mm x 600mm) Tee	3652AN3524
42" x 12" (750mm x 300mm) Tee	4252AN3512
42" x 15" (750mm x 375mm) Tee	4252AN3515
42" x 18" (750mm x 450mm) Tee	4252AN3518
42" x 24" (750mm x 600mm) Tee	4252AN3524
48" x 12" (1200mm x 300mm) Tee	4852AN3512
48" x 15" (1200mm x 375mm) Tee	4852AN3515
48" x 18" (1200mm x 450mm) Tee	4852AN3518
48" x 24" (1200mm x 600mm) Tee	4852AN3524

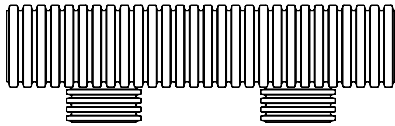

DOUBLE MANIFOLD REDUCING**

*ADDITIONAL ACCESSORIES CAN BE FOUND ON PAGES 29-30.

**ALL STORMTECH REDUCING MANIFOLDS ARE ECCENTRIC.

RETENTION/DETENTION

STORMTECH ACCESSORIES*

SC-310 TRIPLE MANIFOLDS REDUCING

DESCRIPTION	PRODUCT CODE
8" x 6" (200mm x 150mm) Tee	0853AN3106
10" x 6" (250mm x 150mm) Tee	1053AN3106
10" x 8" (250mm x 200mm) Tee	1053AN3108
12" x 6" (300mm x 150mm) Tee	1253AN3106
12" x 8" (300mm x 200mm) Tee	1253AN3108
12" x 10" (300mm x 250mm) Tee	1253AN3110
15" x 6" (375mm x 150mm) Tee	1553AN3106
15" x 8" (375mm x 200mm) Tee	1553AN3108
15" x 10" (375mm x 250mm) Tee	1553AN3110
15" x 12" (375mm x 300mm) Tee	1553AN3112
18" x 6" (450mm x 150mm) Tee	1853AN3106
18" x 8" (450mm x 200mm) Tee	1853AN3108
18" x 10" (450mm x 250mm) Tee	1853AN3110
18" x 12" (450mm x 300mm) Tee	1853AN3112
24" x 6" (600mm x 150mm) Tee	2453AN3106
24" x 8" (600mm x 200mm) Tee	2453AN3108
24" x 10" (600mm x 250mm) Tee	2453AN3110
24" x 12" (600mm x 300mm) Tee	2453AN3112

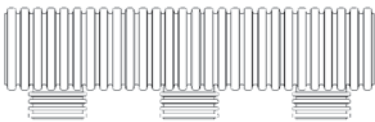

TRIPLE MANIFOLD REDUCING**

SC-740/DC-780 TRIPLE MANIFOLDS REDUCING

DESCRIPTION	PRODUCT CODE
8" x 6" (200mm x 150mm) Tee	0853AN7406
10" x 6" (250mm x 150mm) Tee	1053AN7406
10" x 8" (250mm x 200mm) Tee	1053AN7408
12" x 6" (300mm x 150mm) Tee	1253AN7406
12" x 8" (300mm x 200mm) Tee	1253AN7408
12" x 10" (300mm x 250mm) Tee	1253AN7410
15" x 6" (375mm x 150mm) Tee	1553AN7406
15" x 8" (375mm x 200mm) Tee	1553AN7408
15" x 10" (375mm x 250mm) Tee	1553AN7410
15" x 12" (375mm x 300mm) Tee	1553AN7412
18" x 6" (450mm x 150mm) Tee	1853AN7406
18" x 8" (450mm x 200mm) Tee	1853AN7408
18" x 10" (450mm x 250mm) Tee	1853AN7410
18" x 12" (450mm x 300mm) Tee	1853AN7412
18" x 15" (450mm x 375mm) Tee	1853AN7415
24" x 6" (600mm x 150mm) Tee	2453AN7406
24" x 8" (600mm x 200mm) Tee	2453AN7408
24" x 10" (600mm x 250mm) Tee	2453AN7410
24" x 12" (600mm x 300mm) Tee	2453AN7412
24" x 15" (600mm x 375mm) Tee	2453AN7415
24" x 18" (600mm x 450mm) Tee	2453AN7418
30" x 6" (750mm x 150mm) Tee	3053AN7406
30" x 12" (750mm x 300mm) Tee	3053AN7412
30" x 15" (750mm x 375mm) Tee	3053AN7415
30" x 18" (750mm x 450mm) Tee	3053AN7418
30" x 24" (750mm x 600mm) Tee	3053AN7424
36" x 12" (900mm x 300mm) Tee	3653AN7412
36" x 15" (900mm x 375mm) Tee	3653AN7415
36" x 18" (900mm x 450mm) Tee	3653AN7418
36" x 24" (900mm x 600mm) Tee	3653AN7424
42" x 12" (1050mm x 300mm) Tee	4253AN7412
42" x 15" (1050mm x 375mm) Tee	4253AN7415
42" x 18" (1050mm x 450mm) Tee	4253AN7418
42" x 24" (1050mm x 600mm) Tee	4253AN7424
48" x 12" (1200mm x 300mm) Tee	4853AN7412
48" x 15" (1200mm x 375mm) Tee	4853AN7415
48" x 18" (1200mm x 450mm) Tee	4853AN7418
48" x 24" (1200mm x 600mm) Tee	4853AN7424

*ADDITIONAL ACCESSORIES CAN BE FOUND ON PAGES 29-30.

**ALL STORMTECH REDUCING MANIFOLDS ARE ECCENTRIC.

WATER QUALITY UNIT, GREASE INTERCEPTOR

WATER QUALITY UNIT

DIAMETER	LENGTH	INLET SIZE	OUTLET SIZE	TREATED FLOW RATE	PRODUCT CODE
36" (900mm)	20' (6.1m)	10" (250mm)	10" (250mm)	1.5 cfs (42 L/s)	3620WQA
36" (900mm)	40' (12.2m)	10" (250mm)	10" (250mm)	2.38 cfs (67 L/s)	3640WQA
36" (900mm)	20' (6.1m)	10" (250mm)	10" (250mm)	0.7 cfs (20 L/s)	3620WQB
36" (900mm)	40' (12.2m)	10" (250mm)	10" (250mm)	1.6 cfs (45 L/s)	3640WQB
42" (1050mm)	20' (6.1m)	12" (300mm)	12" (300mm)	1.79 cfs (49 L/s)	4220WQA
42" (1050mm)	40' (12.2m)	12" (300mm)	12" (300mm)	3.66 cfs (104 L/s)	4240WQA
42" (1050mm)	20' (6.1m)	12" (300mm)	12" (300mm)	0.86 cfs (24 L/s)	4220WQB
42" (1050mm)	40' (12.2m)	12" (300mm)	12" (300mm)	1.83 cfs (52 L/s)	4240WQB
48" (1200mm)	20' (6.1m)	12" (300mm)	12" (300mm)	2.26 cfs (64 L/s)	4820WQA
48" (1200mm)	40' (12.2m)	12" (300mm)	12" (300mm)	3.94 cfs (112 L/s)	4840WQA
48" (1200mm)	20' (6.1m)	12" (300mm)	12" (300mm)	1.13 cfs (32 L/s)	4820WQB
48" (1200mm)	40' (12.2m)	12" (300mm)	12" (300mm)	2.39 cfs (68 L/s)	4840WQB
60" (1500mm)	20' (6.1m)	15" (375mm)	15" (375mm)	2.95 cfs (84 L/s)	6020WQA
60" (1500mm)	40' (12.2m)	15" (375mm)	15" (375mm)	6.23 cfs (176 L/s)	6040WQA
60" (1500mm)	20' (6.1m)	15" (375mm)	15" (375mm)	1.47 cfs (42 L/s)	6020WQB
60" (1500mm)	40' (12.2m)	15" (375mm)	15" (375mm)	3.12 cfs (88 L/s)	6040WQB

- Add two digit number at end of product number for bypass size.
- 00 at end of product number indicates no bypass.

MODULE I

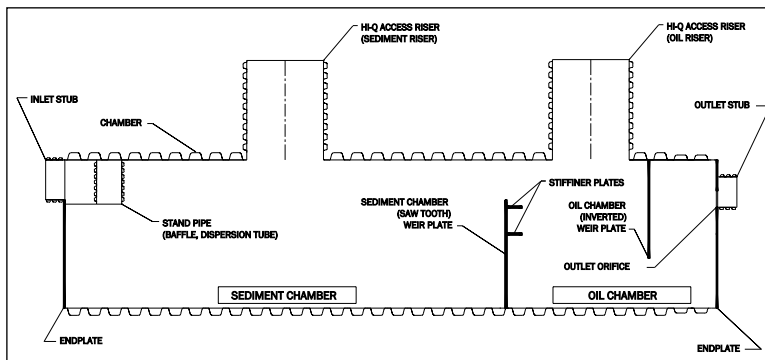

GREASE INTERCEPTOR

DIAMETER	VOLUME	PRODUCT CODE
48" (1200mm)	750 gal (2839 liters)	0750ANGT
48" (1200mm)	1000 gal (3785 liters)	1000ANGT
60" (1200mm)	1500 gal (5678 liters)	1500ANGT

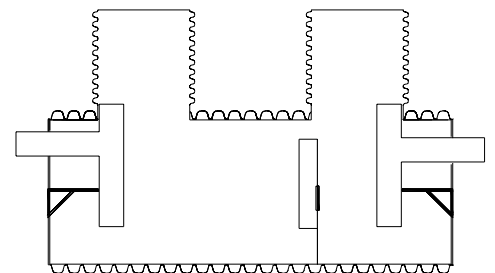

GREASE INTERCEPTOR

FLEXSTORM® INLET FILTERS

FLEXSTORM PURE (PERMANENT) FILTERS

FILTERS FOR ROUND FRAMES/GRATES*

Sizing Guidelines (Opening diameter up to)	Storage Capacity ft ³ (m ³)	FX-Large Sediment + Trash	FX+ Trash + Oils	PC-Oils, Fine Sediments & TSS	PC+ Excessive Oils, Fine Sediments & TSS
18" (450 mm)	1.6 (0.05)	62SHDRFX	62SHDRFXP	62SHDRPC	62SHDRPCP
24" (600 mm)	2.1 (0.06)	62MHDRFX	62MHDRFXP	62MHDRPC	62MHDRPCP
36" (900 mm)	3.8 (0.11)	62LHDRFX	62LHDRFXP	62LHDRPC	62LHDRPCP
42" (1050 mm)	4.2 (0.12)	62XLHDRFX	62XLHDRFXP	62XLHDRPC	62XLHDRPCP



FILTERS FOR RECTANGULAR/ SQUARE FRAMES/GRATES*

Sizing Guidelines (Up to)	Storage Capacity ft ³ (m ³)	FX-Large Sediment + Trash	FX+ Trash + Oils	PC-Oils, Fine Sediments & TSS	PC+ Excessive Oils, Fine Sediments & TSS
16" x 16" (400 x 400 mm)	1.6 (0.05)	62SHDFX	62SHDFXP	62SHDPC	62SHDPCP
24" x 24" (600 x 600 mm)	2.1 (0.06)	62MHDFX	62MHDFXP	62MHDPC	62MHDPCP
36" x 24" (900 x 600 mm)	3.8 (0.11)	62LHDFX	62LHDFXP	62LHDPC	62LHDPCP
48" x 48" (1200 x 1200 mm)	6.6 (0.18)	62XLHDFX	62XLHDFXP	62XLHDPC	62XLHDPCP

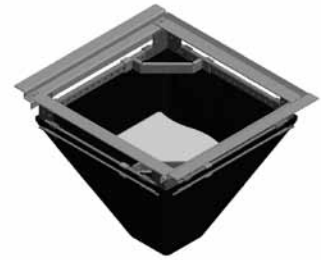

FILTERS FOR OPEN THROAT CURB INLETS*

Sizing Guidelines	Storage Capacity ft ³ (m ³)	FX-Large Sediment + Trash	FX+ Trash + Oils	PC-Oils, Fine Sediments & TSS	PC+ Excessive Oils, Fine Sediments & TSS
Up to 4' (1.2 m)	3.3 (0.09)	6HDWM1FX	6HDWM1FXP	6HDWM1PC	6HDWM1PCP
Between 4' & 8' (1.2 & 2.4 m)	6.6 (0.18)	62HDWM2FX	62HDWM2FXP	62HDWM2PC	62HDWM2PCP
Between 8' & 12' (2.4 & 3.7 m)	9.9 (0.28)	62HDWM3FX	62HDWM3FXP	62HDWM3PC	62HDWM3PCP
Between 12' & 16' (3.6 m & 4.9 m)	13.2 (0.37)	62HDWM4FX	62HDWM4FXP	62HDWM4PC	62HDWM4PCP



*Custom sizes and bag depths available. Typical depth is 22" (550 mm).

FLEXSTORM INLET FILTERS

FLEXSTORM CATCH-IT® (TEMPORARY) FILTERS

FILTERS FOR ROUND FRAMES/GRATES*

OPENING (DIA.) (Up to size opening)	FX Woven Bag
18" (450 mm)	62SRDFX
25" (625 mm)	62MRDFX
30" (750 mm)	62LRDFX
37" (925 mm)	62XLRDFX
48" (1200 mm)	62XXLRDFX



FILTERS FOR RECTANGULAR/ SQUARE FRAMES/GRATES*

OPENING (DIA.) (Up to size opening)	FX Woven Bag
16" x 16" (400 x 400 mm)	62SSQFX
24" x 24" (600 x 600 mm)	62MSQFX
36" x 24" (900 x 600 mm)	62LSQFX
48" x 48" (1200 x 1200 mm)	62XLSQFX



FILTERS FOR RECTANGULAR FRAMES/GRATES/CURB HOODS*

OPENING (DIA.) (Up to size opening)	FX Woven Bag
16" x 16" (400 x 400 mm)	62SCBFX
24" x 24" (600 x 600 mm)	62MCBFX
36" x 24" (900 x 600 mm)	62LCBFX
48" x 48" (1200 x 1200 mm)	62XLCBFX



CATCH-IT LITE FILTERS

FRAME/GRATE TYPE	PRODUCT CODES
Square/Rectangular	62LITE
Square/Rectangular with Curb Opening	62LITECB
Round Frame/Grate	62LITERD



62LITE



62LITECB

*Custom sizes and bag depths available. Typical depth is 22" (550 mm).

FLEXSTORM INLET FILTERS

NYLOPLAST FILTERS, REPLACEMENT BAGS & ACCESSORIES

ROUND NYLOPLAST STAINLESS STEEL

OPENING (DIA.)	FX Woven Bag	FX+ Woven with Oil Skimmer	PC Bag (Adsorb-It Lined)	PC+ Bag	LL: Litter Leaf Bag
8" (200 mm) Drop In/In Line Grates	6208NYFX	6208NYFXP	6208NYPC	6208NYPCP	6208NYLL
10" (250 mm) Drop In/In Line Grates	6210NYFX	6210NYFXP	6210NYPC	6210NYPCP	6210NYLL
12" (300 mm) Nyloplast Casting	6212NYFX	6212NYFXP	6212NYPC	6212NYPCP	6212NYLL
15" (375 mm) Nyloplast Casting	6215NYFX	6215NYFXP	6215NYPC	6215NYPCP	6215NYLL
18" (450 mm) Nyloplast Casting	6218NYFX	6218NYFXP	6218NYPC	6218NYPCP	6218NYLL
24" (600 mm) Nyloplast Casting	6224NYFX	6224NYFXP	6224NYPC	6224NYPCP	6224NYLL
30" (750 mm) Nyloplast Casting	6230NYFX	6230NYFXP	6230NYPC	6230NYPCP	6230NYLL



REPLACEMENT BAGS*

BAG SIZES (Round or Rectangle)	FX	FXP	PC Bag	PCP Bag
Small	62SRBFX	62SRBFXP	62SRBPC	62SRBPCP
Medium	62MRBFX	62MRBFXP	62MRBPC	62MRBPCP
Large	62LRBFX	62LRBFXP	62LRBPC	62LRBPCP
X-Large (Round only)	62XLRBFX	62XLRBFXP	62XLRBPC	62XLRBPCP

*Part numbers listed for standard depth filter bags of 22". To order the 12" deep "short" bags simply add a "-S" suffix to part number.

CLEARTEC RUBBERIZER OIL SKIMMER BAG

BAG SIZES	PCP Bag
Standard Skimmer Pouch with Swivel Hook/Strap	62CTSB
3" diameter x 34" Long Skimmer Boom with Swivel Hook/Strap	62CTSB34

MAINTENANCE TOOL

2-Person to Remove Grates & Filters	62UMT
-------------------------------------	-------



FLEXSTORM INLET FILTERS

FULL TRASH CAPTURE INSERTS

FULL TRASH CAPTURE INSERTS*

DESCRIPTION	BASIN SIZE	BASKET DEPTH	PRODUCT CODE
12" x 12" (300 x 300 mm) Full Trash Capture Insert	12" x 12" (300 x 300 mm)	12" (300 mm)	62HD12FTC
18" x 18" (450 x 450 mm) Full Trash Capture Insert	18" x 18" (450 x 450 mm)	12" (300 mm)	62HD18FTC
24" x 24" (600 x 600 mm) Full Trash Capture Insert	24" x 24" (600 x 600 mm)	12" (300 mm)	62HD24FTC
36" x 18" (900 x 450 mm) Full Trash Capture Insert	36" x 18" (900 x 450 mm)	12" (300 mm)	62HD3618FTC
36" x 24" (900 x 600 mm) Full Trash Capture Insert	36" x 24" (900 x 600 mm)	12" (300 mm)	62HD3624FTC
36" x 36" (900 x 900 mm) Full Trash Capture Insert	36" x 36" (900 x 900 mm)	12" (300 mm)	62HD36FTC



ROUND GRATE FILTER



SQUARE/RECTANGULAR GRATE FILTER

* Custom sizes and basket depths available.

CURB INLETS FULL TRASH CAPTURE INSERTS*

DESCRIPTION	CURB OPENING WIDTH in. (mm)	BASKET DEPTH	PRODUCT CODE
36" (900 mm) Curb Inlet Full Trash Capture Insert	36" (900 mm)	12" (300 mm)	62HDWM36FTC
42" (1050 mm) Curb Inlet Full Trash Capture Insert	42" (1050 mm)	12" (300 mm)	62HDWM42FTC
48" (1200 mm) Curb Inlet Full Trash Capture Insert	48" (1200 mm)	12" (300 mm)	62HDWM48FTC
60" (1500 mm) Curb Inlet Full Trash Capture Insert	60" (1500 mm)	12" (300 mm)	62HDWM60FTC
72" (1800 mm) Curb Inlet Full Trash Capture Insert	72" (1800 mm)	12" (300 mm)	62HDWM72FTC
84" (2100 mm) Curb Inlet Full Trash Capture Insert	84" (2100 mm)	12" (300 mm)	62HDWM84FTC
96" (2400 mm) Curb Inlet Full Trash Capture Insert	96" (2400 mm)	12" (300 mm)	62HDWM96FTC
120" (3000 mm) Curb Inlet Full Trash Capture Insert	120" (3000 mm)	12" (300 mm)	62HDWM120FTC

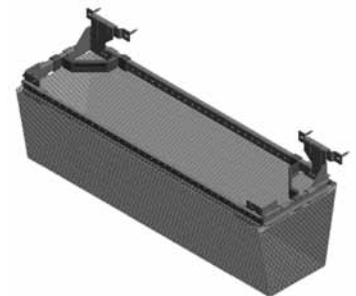

CURB INLET INSERT

* Custom sizes and basket depths available.

FLEXSTORM INLET FILTERS

Connector Pipe Screen

CONNECTOR PIPE SCREEN U-SHAPE*

DESCRIPTION	SCREEN LENGTH	SCREEN HEIGHT	PRODUCT CODE	REFERENCE CODE
36" x 18" (900 x 450 mm) Connector Pipe Screen	36" (900 mm)	18" (450 mm)	62CPS	3L18H-Bypass-U
48" x 18" (1200 x 450 mm) Connector Pipe Screen	48" (1200 mm)	18" (450 mm)	62CPS	4L18H-Bypass-U
60" x 18" (1500 x 450 mm) Connector Pipe Screen	60" (1500 mm)	18" (450 mm)	62CPS	5L18H-Bypass-U



CONNECTOR PIPE SCREEN L-SHAPE*

DESCRIPTION	SCREEN LENGTH	SCREEN HEIGHT	PRODUCT CODE	REFERENCE CODE
36" x 18" (900 x 450 mm) Connector Pipe Screen	36" (900 mm)	18" (450 mm)	62CPS	3L18H-Bypass-L
48" x 18" (1200 x 450 mm) Connector Pipe Screen	48" (1200 mm)	18" (450 mm)	62CPS	4L18H-Bypass-L
60" x 18" (1500 x 450 mm) Connector Pipe Screen	60" (1500 mm)	18" (450 mm)	62CPS	5L18H-Bypass-L

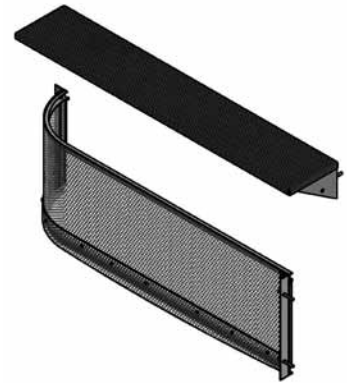

CONNECTOR PIPE SCREEN U EXTENDED SHAPE*

DESCRIPTION	SCREEN LENGTH	SCREEN HEIGHT	PRODUCT CODE	REFERENCE CODE
36" x 18" (900 x 450 mm) Connector Pipe Screen	36" (900 mm)	18" (450 mm)	62CPS	3L18H-Bypass-UEXT
48" x 18" (1200 x 450 mm) Connector Pipe Screen	48" (1200 mm)	18" (450 mm)	62CPS	4L18H-Bypass-UEXT
60" x 18" (1500 x 450 mm) Connector Pipe Screen	60" (1500 mm)	18" (450 mm)	62CPS	5L18H-Bypass-UEXT



* Custom shapes and sizes available. Bypass height determined by catch basin size.

BAYSAVER STORMWATER TREATMENT

BayFilter™, BaySeparator™, Barracuda™

BAYFILTER STORMWATER TREATMENT

MODEL	DIAMETER	FLOW RATE	MEDIA AREA	SEDIMENT CAPTURE CAPACITY	PRODUCT CODE
BayFilter 545	28" (711 mm)	45 gpm (170 l/min)	90 ft ² (8.4 m ²)	350 lbs (159 kg)	BAYFLTR-545
BayFilter 530	28" (711 mm)	30 gpm (114 l/min)	90ft ² (8.4 m ²)	350 lbs (159 kg)	BAYFLTR-530
BayFilter 522	28" (711 mm)	22.5 gpm (85 l/min)	45 ft ² (4.2 m ²)	175 lbs (79 kg)	BAYFLTR-522
BayFilter 645	28" (711 mm)	45 gpm (170 l/min)	90 ft ² (8.4 m ²)	350 lbs (159 kg)	BAYFLTR-645
BayFilter 630	28" (711 mm)	30 gpm (114 l/min)	90 ft ² (8.4 m ²)	350 lbs (159 kg)	BAYFLTR-630
BayFilter 622	28" (711 mm)	22.5 gpm (85 l/min)	45 ft ² (4.2 m ²)	175 lbs (79 kg)	BAYFLTR-622



BAYSEPARATOR STORMWATER TREATMENT

MODEL	MANHOLE DIAMETER	MANHOLE DEPTH	MAXIMUM TREATMENT RATE	MAXIMUM HYDRAULIC RATE	PRODUCT CODE
BaySeparator ½K	48" (1219 mm)	6' (1.8 m)	1.1 cfs (31.4 l/sec)	8.5 cfs (241 l/sec)	BAYSEP00500
BaySeparator 1K	48" (1219 mm)	8' (2.4 m)	2.4 cfs (68 l/sec)	10 cfs (283 l/sec)	BAYSEP01000
BaySeparator 3K	60" (1524 mm)	8' (2.4 m)	7.8 cfs (221 l/sec)	30 cfs (850 l/sec)	BAYSEP03000
BaySeparator 5K	72" (1829 mm)	8' (2.4 m)	11.1 cfs (314 l/sec)	50 cfs (1416 l/sec)	BAYSEP05000
BaySeparator 10K	120" (3048 mm)	8' (2.4 m)	21.8 cfs (617 l/sec)	100 cfs (2832 l/sec)	BAYSEP10000
BaySeparator XK	Custom	Custom	Custom	Custom	BAYSYSXK

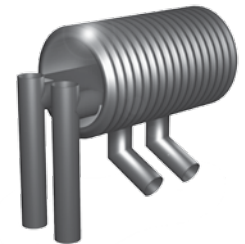

BARRACUDA

MODEL	MANHOLE DIAMETER	OK-110 (80% REMOVAL)	NJCAT/NJDEP (50% TSS REMOVAL)
S4	48" (1219 mm)	1.08 cfs (30.6 l/sec)	1.25 cfs (35.4 l/sec)
S6	72" (1829 mm)	2.43 cfs (68.8 l/sec)	2.80 cfs (79.3 l/sec)
S8	96" (2438 mm)	4.32 cfs (122.3 l/sec)	5.00 cfs (141.6 l/sec)



DURASLOT® SURFACE DRAINS

DURASLOT SURFACE DRAINS

PIPE DIAMETER	SLOT HEIGHT	PRODUCT CODE
4" (100mm)	2.5" (64mm)	0420DS
4" (100mm)	Variable	0490DS
6" (150mm)	2.5" (64mm)	0620DS
6" (150mm)	6" (150mm)	0660DS
6" (150mm)	6" (150mm) Open Top	0660DSOT
6" (150mm)	Variable	0690DS
6" (150mm)	Variable Open Top	0690DSOT
8" (200mm)	2.5" (64mm)	0820DS
8" (200mm)	6" (150mm)	0860DS
8" (200mm)	6" (150mm) Open Top	0860DSOT
8" (200mm)	Variable	0890DS
8" (200mm)	Variable Open Top	0890DSOT
10" (250mm)	2.5" (64mm)	1020DS
10" (250mm)	6" (150mm)	1060DS
10" (250mm)	6" (150mm) Open Top	1060DSOT
10" (250mm)	Variable	1090DS
10" (250mm)	Variable Open Top	1090DSOT
12" (300mm)	2.5" (64mm)	1220DS
12" (300mm)	6" (150mm)	1260DS
12" (300mm)	6" (150mm) Open Top	1260DSOT
12" (300mm)	Variable	1290DS
12" (300mm)	Variable Open Top	1290DSOT
15" (375mm)	6" (150mm)	1560DS
15" (375mm)	6" (150mm) Open Top	1560DSOT
15" (375mm)	Variable	1590DS
15" (375mm)	Variable Open Top	1590DSOT
18" (450mm)	6" (150mm)	1860DS
18" (450mm)	6" (150mm) Open Top	1860DSOT
18" (450mm)	Variable	1890DS
18" (450mm)	Variable Open Top	1890DSOT
24" (600mm)	6" (150mm)	2460DS
24" (600mm)	6" (150mm) Open Top	2460DSOT
24" (600mm)	Variable	2490DS
24" (600mm)	Variable Open Top	2490DSOT
30" (750mm)	6" (150mm)	3060DS
30" (750mm)	6" (150mm) Open Top	3060DSOT
30" (750mm)	Variable	3090DS
30" (750mm)	Variable Open Top	3090DSOT
36" (900mm)	6" (150mm)	3660DS
36" (900mm)	Variable	3690DS
36" (900mm)	Variable Open Top	3690DSOT

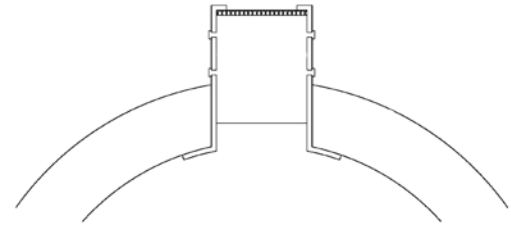
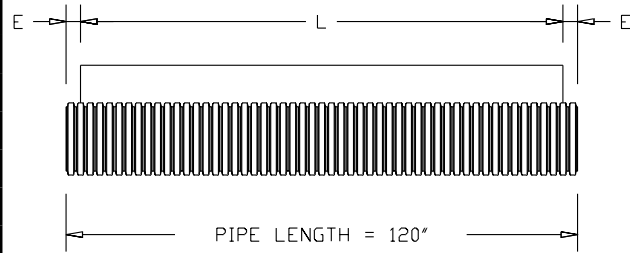

DURASLOT WITH GRATE

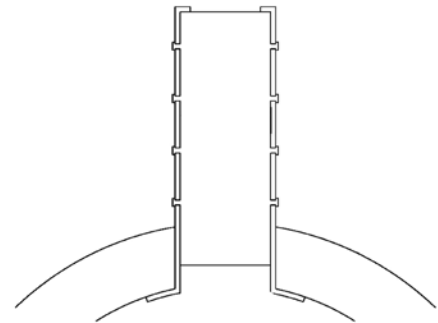

OPEN TOP DURASLOT

DURASLOT SURFACE DRAINS FITTINGS

COUPLERS

PIPE DIAMETER	FITTING COMPATIBLE WITH PRODUCT CODE	PRODUCT CODE
4" (100mm)	0420DS	0421DS
4" (100mm)	0490DS	0491DS
6" (150mm)	0660DS	0626DS
6" (150mm)	0690DS	0691DS
8" (200mm)	0860DS	0826DS
8" (200mm)	0890DS	0891DS
10" (250mm)	1060DS	1026DS
10" (250mm)	1090DS	1091DS
12" (300mm)	1260DS	1226DS
12" (300mm)	1290DS	1291DS
15" (375mm)	1560DS	1526DS
15" (375mm)	1590DS	1591DS
18" (450mm)	1860DS	1826DS
18" (450mm)	1890DS	1891DS
24" (600mm)	2460DS	2426DS
24" (600mm)	2490DS	2491DS
30" (750mm)	3060DS	3026DS
30" (750mm)	3090DS	3091DS
36" (900mm)	3660DS	3626DS
36" (900mm)	3690DS	3691DS



4" COUPLER

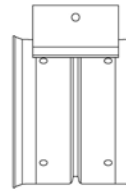

6" COUPLER

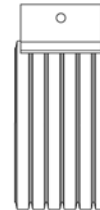

8" & 10" COUPLER

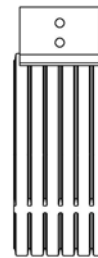

12"-36" COUPLER

DURASLOT SURFACE DRAINS FITTINGS

END CAPS

PIPE DIAMETER	FITTING COMPATIBLE WITH PRODUCT CODE	PRODUCT CODE
4" (100mm)	0420DS	0433DS
4" (100mm)	0490DS	0493DS
6" (150mm)	0660DS	0633DS
6" (150mm)	0690DS	0693DS
8" (200mm)	0860DS	0833DS
8" (200mm)	0890DS	0893DS
10" (250mm)	1060DS	1033DS
10" (250mm)	1090DS	1093DS
12" (300mm)	1260DS	1233DS
12" (300mm)	1290DS	1293DS
15" (375mm)	1560DS	1533DS
15" (375mm)	1590DS	1593DS
18" (450mm)	1860DS	1833DS
18" (450mm)	1890DS	1893DS
24" (600mm)	2460DS	2433DS
24" (600mm)	2490DS	2493DS
30" (750mm)	3060DS	3033DS
30" (750mm)	3090DS	3093DS
36" (900mm)	3660DS	3633DS
36" (900mm)	3690DS	3693DS

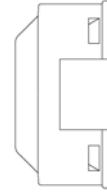

4" & 8" END CAP

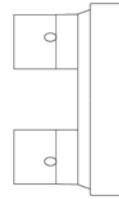

6" & 10" END CAP

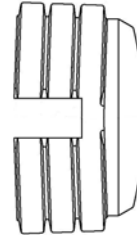

12"-36" END CAP

DURASLOT SURFACE DRAINS FITTINGS

ADAPTERS

PIPE DIAMETER	FITTING COMPATIBLE WITH PRODUCT CODE	PRODUCT CODE
4" (100mm)	0420DS	0462DS
4" (100mm)	0490DS	0496DS
6" (150mm)	0660DS	0662DS
6" (150mm)	0690DS	0696DS
8" (200mm)	0860DS	0862DS
8" (200mm)	0890DS	0896DS
10" (250mm)	1060DS	1062DS
10" (250mm)	1090DS	1096DS
12" (300mm)	1260DS	1262DS
12" (300mm)	1290DS	1296DS
15" (375mm)	1560DS	1562DS
15" (375mm)	1590DS	1596DS
18" (450mm)	1860DS	1862DS
18" (450mm)	1890DS	1896DS
24" (600mm)	2460DS	2462DS
24" (600mm)	2490DS	2496DS
30" (750mm)	3060DS	3062DS
30" (750mm)	3090DS	3096DS
36" (900mm)	3660DS	3662DS
36" (900mm)	3690DS	3696DS



4" ADAPTER

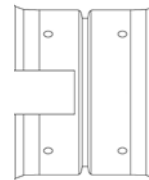

6"-10" ADAPTER

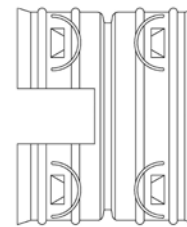

12"-24" ADAPTER

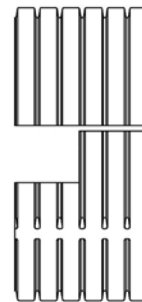

30"-36" ADAPTER

ADVANEDGE® PIPE

12" AND 18" ADVANEDGE PIPE

DIAMETER	LENGTH	DESCRIPTION	PRODUCT CODE
12" (300mm)	100' (30.5m)	No Fabric	04900100
	100' (30.5m)	3.5 oz. Spunbond	04910100
	100' (30.5m)	4.0 oz. Spunbond	04930100
	400' (121.9m)	4.0 oz. Spunbond	04930400
	112' (34.1m)	4.0 oz. Spunbond	04930112
	100' (30.5m)	Knitted Polyester Sock	04940100
	100' (30.5m)	4.0 oz. Amoco Fabric (Grey)	04950100
18" (450mm)	100' (30.5m)	No Fabric	06900100
	100' (30.5m)	4.0 oz. Fabric	06930100
	1600' (487.7m)	4.0 oz. Fabric	06931600
	100' (30.5m)	4.0 oz. Needleponched Fabric	06950100



ADVANEDGE FITTINGS

ADVANEDGE FITTINGS

PIPE SIZE	FITTING	PRODUCT CODE
12" (300mm)	Snap End Cap	1432AA
18" (450mm)		1632AA
12" (300mm)	External Split Coupler	1411AA
18" (450mm)		1611AA
12" (300mm)	Wye	1480AA
12" (300mm) and 18" (450mm)	Coupling Pin (2/pk)	0840MB
12" (300mm)	End Outlet	1472AA
18" (450mm)		1672AA
12" (300mm)	Side Outlet	1471AA
18" (450mm)		1671AA
4" (100mm)	12" (300mm) Flat Outlet	1432AN
12" (300mm)	Fabricated Tee	1460AN
18" (450mm)		1660AN
12" (300mm)	Fabricated Tee (Horizontal)	1460ANH
18" (450mm)		1660ANH
12" (300mm)	Fabricated Tee with Side Outlet	1464ANH
12" (300mm)	Fabricated Tee with Perf Side Outlet	1464ANH81
12" (300mm)	Fabricated Cross Tee (Horizontal)	1436ANH
12" (300mm)	Fabricated Wye	1480AN
18" (450mm)		1680AN
12" (300mm)	Fabricated Wye (Horizontal)	1480ANH
18" (450mm)		1680ANH
12" (300mm)	Fabricated Cross Wye	1438ANH

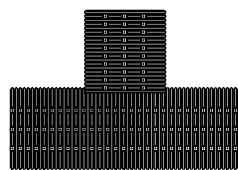
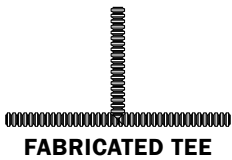
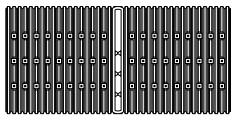
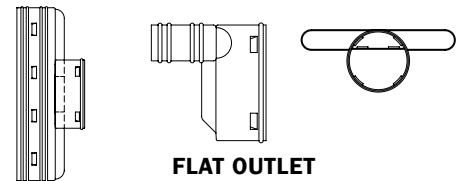
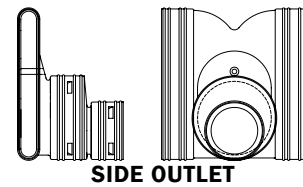
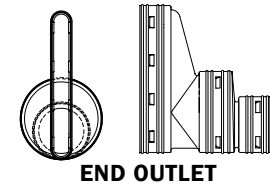
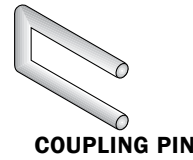
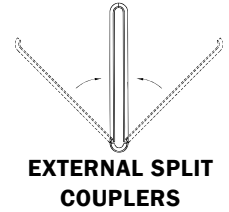
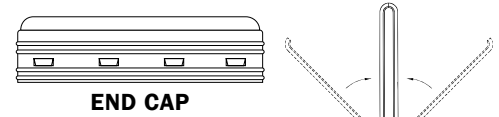

FABRICATED TEE (HORIZONTAL)

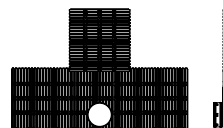

FABRICATED TEE WITH SIDE OUTLET

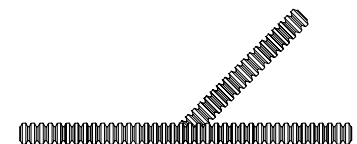

WYE

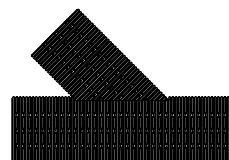
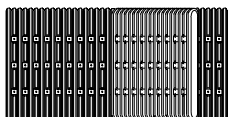

FABRICATED WYE (HORIZONTAL)

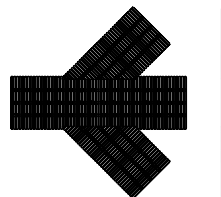

FABRICATED CROSS WYE

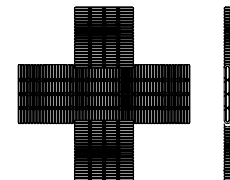

FABRICATED CROSS TEE

ARC™ CHAMBERS & ACCESSORIES

ARC CHAMBERS

TYPE	LOAD RATING	NOMINAL DIMENSIONS (L x W x H)	CAPACITY	PRODUCT CODE
Arc 18	H-10	67" x 16" x 12" (1702mm x 406mm x 300mm)	3.42 ft. ³ (0.10m ³)	1812BD
Arc 24	H-10	67" x 22.5" x 12" (1702mm x 572mm x 300mm)	5.02 ft. ³ (0.14m ³)	2412BD
Arc 36	H-10	63" x 34.5" x 13" (1600mm x 876mm x 330mm)	8 ft. ³ (0.23m ³)	3613BD2
Arc 36HC	H-10	63"x 34.5" x 16" (1600mm x 876mm x 400mm)	10.7 ft. ³ (0.30m ³)	3616BD2
Arc 36LP	H-10	63" x 34" x 8" (1600mm x 864mm x 200mm)	5.84 ft. ³ (0.17m ³)	3608BD



ARC 18



ARC 24



ARC 36



ARC 36HC



ARC 36LP

ARC ACCESSORIES

TYPE	PRODUCT CODE
Arc 18 Endcap	1802BD
Arc 24 Endcap	2402BD
Arc 36 Endcap	3603BD2
Arc 36HC Endcap	3606BD3
Arc 36LP Endcap	3624LPEC
Arc 24 Side Port Coupler	2403BD
Arc 36 Side Port Coupler	3604BD
Arc 36HC Side Port Coupler	3607BD
Endcap Splash Plate	0068



END CAP



SIDE PORT COUPLER

BIODIFFUSER® & ACCESSORIES

BIODIFFUSER CHAMBERS

TYPE	LOAD RATING	NOMINAL DIMENSIONS (L x W x H)	CAPACITY	PRODUCT CODE
15" (375mm) Narrow	H-10	87" x 15" x 12" (2210mm x 375mm x 300mm)	5.0 cu. ft. (0.14m ³)	1500BD
22" (560mm) Narrow	H-10	87" x 22" x 12" (2210mm x 560mm x 300mm)	8.5 cu. ft. (0.24m ³)	2200BD
11" (280mm) Standard	H-10	76" x 34" x 11" (1930mm x 863mm x 280mm)	9.2 cu. ft. (0.26m ³)	1100BD
16" (400mm) Hi Capacity	H-10	76" x 34" x 16" (1930mm x 863mm x 400mm)	13.6 cu. ft. (0.39m ³)	1600BD
16" (400mm) Hi Capacity	H-20	76" x 34" x 16" (1930mm x 863mm x 400mm)	13.6 cu. ft. (0.39m ³)	1620BD

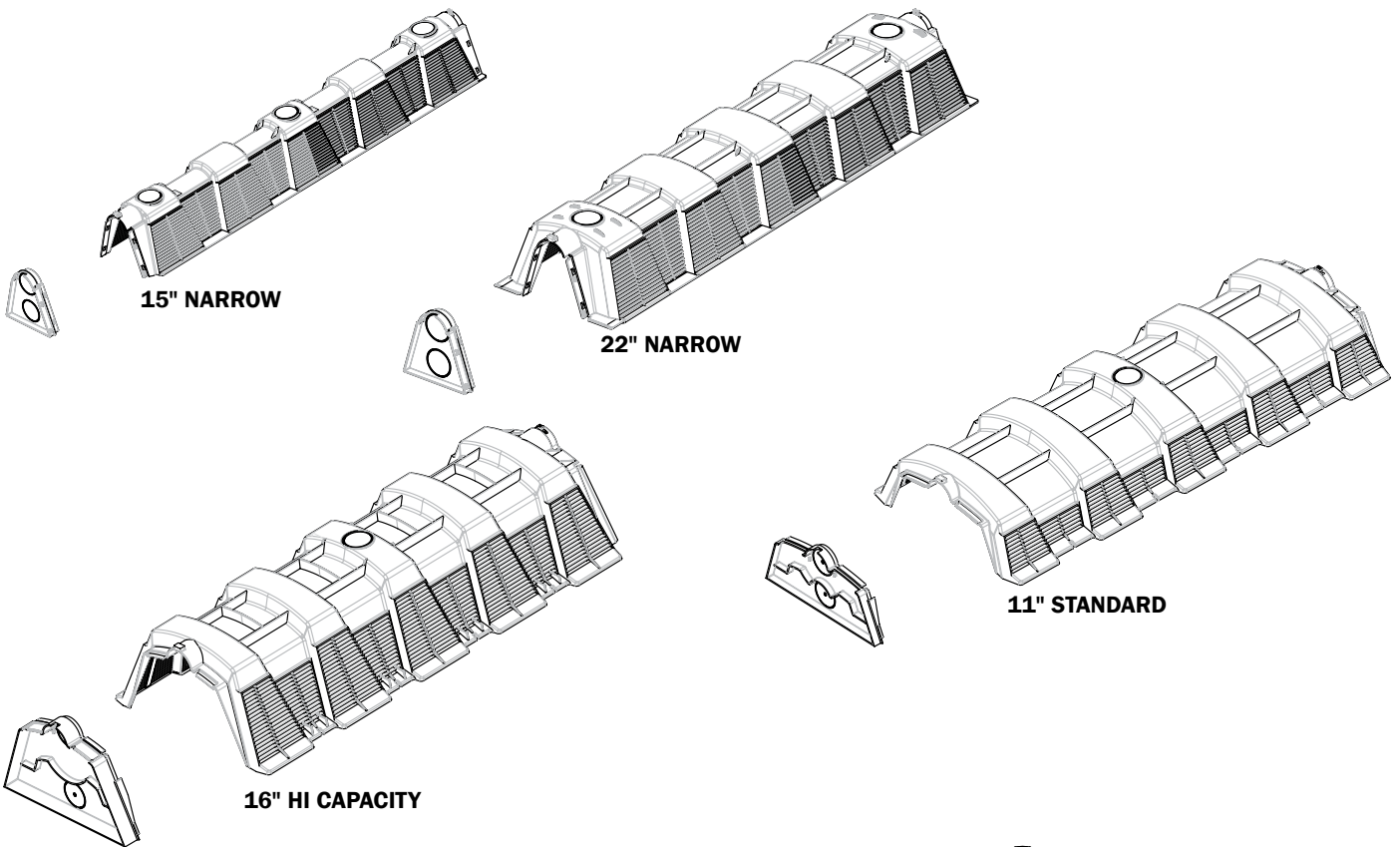

BIODIFFUSER ACCESSORIES

TYPE	PRODUCT CODE
11" (280mm) Endcap	1101BD
11" (280mm) Angle Section 0°-22°	1122BD
16" (400mm) Endcap	1601BD
16" (400mm) Angle Section 0°-22°	1622BD
15" (375mm) Endcap	1501BD
15" (375mm) Angle Section 0°-22°	1522BD

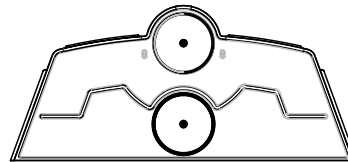

11" STANDARD ENDCAP

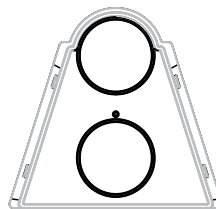

15" AND 22" NARROW ENDCAP

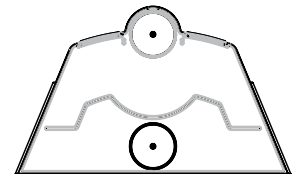

16" HI CAPACITY ENDCAP

SEPTIC STACK™ SYSTEMS

SEPTIC STACK SYSTEM

DESCRIPTION	NOMINAL LENGTH	PRODUCT CODE
4" (100 mm) Perforated 9 Pipe at 10' (3 m) each	10' (3 m)	04710090
4" (100 mm) Perforated 11 Pipe at 10' (3 m) each	10' (3 m)	04710110
4" (100 mm) Perforated 13 Pipe at 10' (3 m) each	10' (3 m)	04710130
3611 System of 4" (100 mm) Perforated Pipe	10' (3 m)	04710110
3613 System of 4" (100 mm) Perforated Pipe	10' (3 m)	04710130

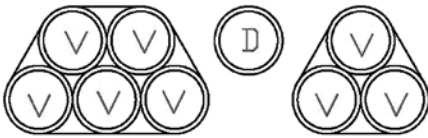

9 PIPE SEPTIC STACK

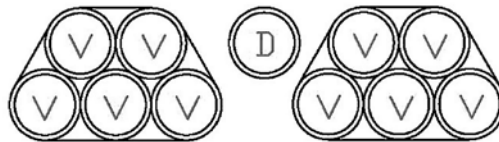

11 PIPE SEPTIC STACK

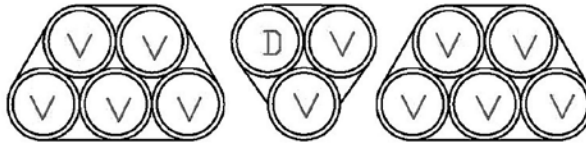

13 PIPE SEPTIC STACK

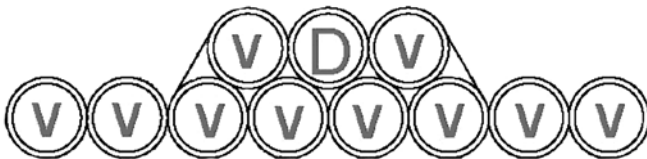

3611 SYSTEM

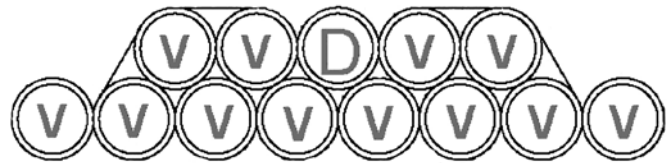

3613 SYSTEM

WASTE WATER ACCESSORIES

WASTE WATER ACCESSORIES

DESCRIPTION	PRODUCT CODE
 Bull Run Valve with 24" (600mm) Key	4182FG
Multi-purpose Regular Distribution Box	1369AB
Multi-purpose Hillside Distribution Box	1370AB
Regular Distribution Box Plug	1379AB
Hillside Distribution Box Plug	1380AB
Lid Kit for Sewage Ejector Sump and Radon Vented Sump	1530ADLX
18" x 30" Sewage Ejector Sump with PVC Hub	1530ADE



BULL RUN VALVE

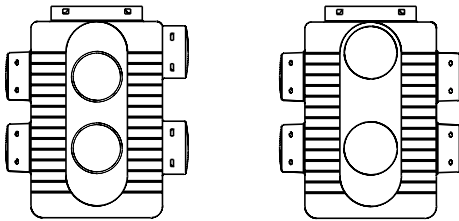

MULTI-PURPOSE DISTRIBUTION BOX HILLSIDE

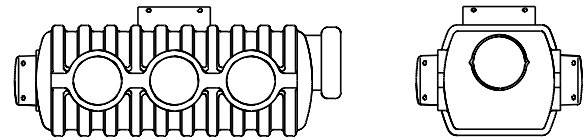

MULTI-PURPOSE DISTRIBUTION BOX REGULAR

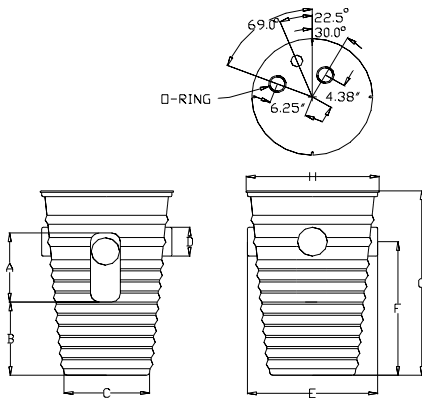

SEWAGE EJECTOR SUMP AND LID

VENTED ELLS & BAFFLES

DESCRIPTION	PRODUCT CODE
4" (100mm) Vented Ells	0497AA
4" (100mm) Vented Ell	0497AAFL*
4" (100mm) Vented Baffle, 3" (75mm) Spur	0493AA

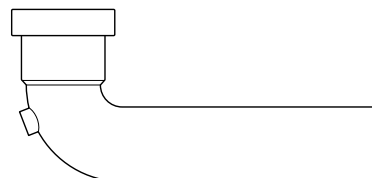

VENTED ELL

*LIMITED GEOGRAPHIC AVAILABILITY.

FOUNDATION DRAINAGE & ACCESSORIES

FOUNDATION DRAINAGE PRODUCTS

DESCRIPTION	DIMENSIONS	PRODUCT CODE
14 gal. (53L) Sump Liner	18" diameter x 24" height (450mm x 600mm)	1524ADH
19 gal. (72L) Sump Liner	18" diameter x 30" height (450mm x 750mm)	1530ADH
14 gal. (53L) Sump Liner	18" diameter x 24" height (450mm x 600mm)	1524ADL
19 gal. (72L) Sump Liner	18" diameter x 30" height (450mm x 750mm)	1530ADL
Standard, Non-Locking Sump Lid	18" diameter (450mm)	1536AD**
Solid, Non-Locking Sump Lid	18" diameter (450mm)	1537AD**
Solid, Locking Sump Lid	18" diameter (450mm)	1537ADL**
Notched, Locking Sump Lid	18" diameter (450mm)	1537ADNL**
Radon Dual Purpose Vented Liner	20" diameter x 24" height (500mm x 600mm)	1524ADR
Sewage Ejector Sump Liner	20" diameter x 30" height (500mm x 750mm)	1530ADE
Non-Locking Lid Kit for Sewage Ejector Sump and Radon Vented Sump	20" diameter (500mm)	1530ADLX*

**For use with ADS 1524ADL and 1530ADL.

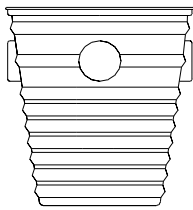

SUMP WELL

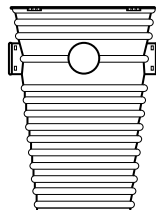

SUMP WELL

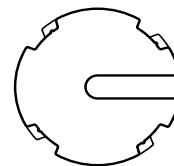

NOTCHED, LOCKING SUMP LID



STANDARD, NON-LOCKING SUMP LID

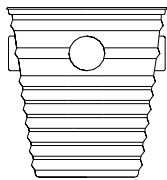

RADON SUMP WELL

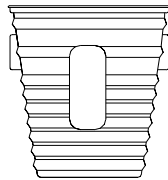

SEWAGE EJECTOR SUMP WELL



SOLID, NON-LOCKING SUMP LID

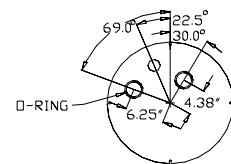

NON-LOCKING LID KIT FOR SEWAGE EJECTOR & RADON SUMP

LAYOUT FLAGS, BLACK TAPE & VENT TUBE SEALING KITS



DESCRIPTION	AVAIL. LENGTHS	PRODUCT CODE
Layout Flags	—	MR F00 00 0000
2" (50mm) Black Tape	100 ft. (30.5m) roll	1137KA
½" (12.5mm) Black Filament Tape	100 ft. (30.5m) roll	1147KA
Vent Tube Kit #1	—	VENT-TUBE-KIT1
Vent Tube Kit #2	—	VENT-TUBE-KIT2

METER PITS & WATERSTOP GASKETS

METER PITS*

I.D. x LENGTH	PRODUCT CODE
18" x 24" (450mm x 600mm)	1805ACH
18" x 30" (450mm x 750mm)	1805AAH
18" x 36" (450mm x 900mm)	1805ABH
18" x 42" (450mm x 1050mm)	1805ADH
18" x 48" (450mm x 1200mm)	1805AEH
21" x 24" (525mm x 600mm)	2105ACH
21" x 30" (525mm x 750mm)	2105AAH
21" x 36" (525mm x 900mm)	2105ABH
21" x 48" (525mm x 1200mm)	2105AEH
24" x 24" (600mm x 600mm)	2405ACH
24" x 30" (600mm x 750mm)	2405AAH
24" x 36" (600mm x 900mm)	2405ABH
24" x 42" (600mm x 1050mm)	2405ADH
24" x 48" (600mm x 1200mm)	2405AEH
18" x 12' (450mm x 3.5m) (UNCUT SECTION)	18050012H
21" x 12' (525mm x 3.5m) (UNCUT SECTION)	21050012H
24" x 12' (600mm x 3.5m) (UNCUT SECTION)	24050012H

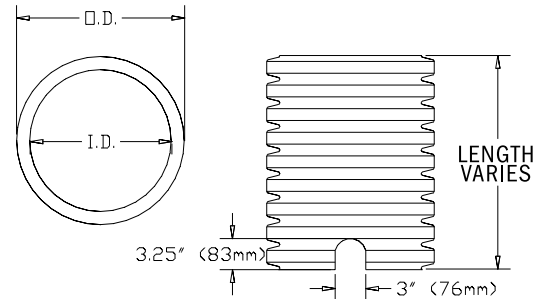

METER PITS

*ALL METER PITS ARE WHITE AND NOTCHED.
UNCUT SECTIONS DO NOT HAVE NOTCHES.

WATERSTOP GASKETS

PIPE SIZE	RECOMMENDED MINIMUM HOLE DIAMETER	MINIMUM DISTANCE PIPE INVERT TO STRUCTURE INVERT	PRODUCT CODE
12" (300mm)	19.50" (495mm)	3.7" (94mm)	1202PS
15" (375mm)	23.00" (584mm)	4.0" (102mm)	1502PS
18" (450mm)	26.50" (673mm)	4.2" (107mm)	1802PS
24" (600mm)	33.25" (845mm)	4.5" (114mm)	2402PS
30" (750mm)	40.50" (1029mm)	5.2" (132mm)	3002PS
36" (900mm)	47.00" (1194mm)	5.5" (140mm)	3602PS
42" (1050mm)	53.00" (1346mm)	5.75" (146mm)	4202PS
48" (1200mm)	59.00" (1499mm)	5.75" (146mm)	4802PS
*54" (1350mm)	65.00" (1651mm)	6.4" (163mm)	5402PS
60" (1500mm)	72.00" (1829mm)	6.4" (163mm)	6002PS

*Limited Geographical Availability

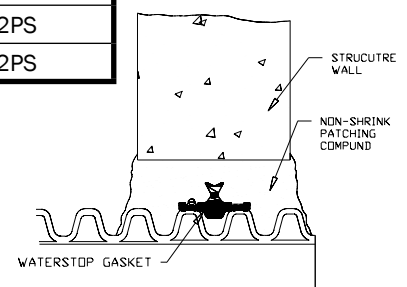

*LIMITED GEOGRAPHIC AVAILABILITY.

GEOSYNTHETICS

NONWOVEN

LIGHTWEIGHT – NONWOVEN



WEIGHT	W X L	SY/ROLL	PRODUCT CODE
3 oz. (85 g)	12.5' x 360' (3.8m x 109.7m)	500 (418 m ²)	0311TG
3 oz. (85 g)	15' x 360' (4.6m x 109.7m)	600 (502 m ²)	0311TS
3.5 oz. (99 g)	12.5' x 360' (3.8m x 109.7m)	500 (418 m ²)	0351TG
3.5 oz. (99 g)	15' x 360' (4.6m x 109.7m)	600 (502 m ²)	0351TS
4.0 oz. (113 g)	12.5' x 360' (3.8m x 109.7m)	500 (418 m ²)	0401TG
4.0 oz. (113 g)	15' x 360' (4.6m x 109.7m)	600 (502 m ²)	0401TS
4.5 oz. (128 g)	12.5' x 360' (3.8m x 109.7m)	500 (418 m ²)	0451TG
4.5 oz. (128 g)	15' x 360' (4.6m x 109.7m)	600 (502 m ²)	0451TS

MEDIUM WEIGHT – NONWOVEN



WEIGHT	W X L	SY/ROLL	PRODUCT CODE
6 oz. (170 g)	12.5' x 360' (3.8m x 109.7m)	500 (418 m ²)	0601TG
6 oz. (170 g)	15' x 300' (4.6m x 91.4m)	500 (418 m ²)	0601TS
7 oz. (198 g)	6' x 360' (1.8m x 109.7m)	240 (201 m ²)	0701TE
7 oz. (198 g)	12.5' x 360' (3.8m x 109.7m)	500 (418 m ²)	0701TG
7 oz. (198 g)	15' x 300' (4.6m x 91.4m)	500 (418 m ²)	0701TS
8 oz. (227 g)	12.5' x 360' (3.8m x 109.7m)	500 (418 m ²)	0801TG
8 oz. (227 g)	15' x 300' (4.6m x 91.4m)	500 (418 m ²)	0801TS

HEAVY WEIGHT – NONWOVEN



WEIGHT	W X L	SY/ROLL	PRODUCT CODE
10 oz. (284 g)	15' x 300' (4.6m x 91.4m)	500 (418 m ²)	1001TS
12 oz. (340 g)	15' x 300' (4.6m x 91.4m)	500 (418 m ²)	1201TS
16 oz. (454 g)	15' x 300' (4.6m x 91.4m)	500 (418 m ²)	1601TS

*ADDITIONAL WIDTHS AVAILABLE 2' (0.6 m), 3' (0.9 m), 4' (1.2 m), 7.5' (2.3 m).

GEOSYNTHETICS

WOVEN & GEOGRIDS

WOVEN FABRIC SYR STABILIZATION – WOVEN



GRAB TENSILE	W X L	SY/ROLL	PRODUCT CODE
200	12.5' x 432' (3.8m x 131.7m)	600 (502 m ²)	200WTK
200	15' x 360' (4.6m x 109.7m)	600 (502 m ²)	200WTS
200	17.5' x 309' (5.3m x 94.2m)	600 (502 m ²)	200WTM
250	12.5' x 360' (3.8m x 109.7m)	500 (418 m ²)	250WTK
250	17.5' x 258' (5.3m x 78.6m)	500 (418 m ²)	250WTM
270	12.5' x 360' (3.8m x 109.7m)	500 (418 m ²)	270WTK
270	15' x 300' (4.6m x 91.4m)	500 (418 m ²)	270WTS
270	17.5' x 258' (5.3m x 78.6m)	500 (418 m ²)	270WTM
315	12.5' x 360' (3.8m x 109.7m)	500 (418 m ²)	315WTK
315	15' x 300' (4.6m x 91.4m)	500 (418 m ²)	315WTS
315	17.5' x 258' (5.3m x 78.6m)	500 (418 m ²)	315WTM
465	12.5' x 360' (3.8m x 109.7m)	500 (418 m ²)	315WTK

WOVEN FABRIC SYR MONOFILAMENT – WOVEN



W X L	SY/ROLL	PRODUCT CODE
12' x 300' (3.6m x 91.4m)	400 (334 m ²)	104FWF
15' x 300' (4.6m x 91.4m)	500 (418 m ²)	2x2HFTS
12.5' x 300' (3.8m x 91.4m)	417 (348 m ²)	111FTK
12' x 300' (3.6m x 91.4m)	400 (334 m ²)	117FTK

WOVEN FABRIC SYR MEDIUM STRENGTH – WOVEN



W X L	SY/ROLL	PRODUCT CODE
15' x 300' (4.6m x 91.4m)	500 (418 m ²)	270HPTS
17' x 258' (5.3m x 78.6m)	500 (418 m ²)	270HPTM
17.5' x 257' (5.3m x 78.3m)	500 (418 m ²)	370HPTS
15' x 300' (4.6m x 91.4m)	500 (418 m ²)	570HPTS

BIAXIAL GEOGRIDS



W X L	SY/ROLL	PRODUCT CODE
13.1' x 246' (4.0 m x 75.0 m)	359 (300 m ²)	BX114GG
13.1' x 164' (4.0 m x 50.0 m)	239 (200m ²)	BX124GG
13.1' x 164' (4.0m x 50.0m)	239 (200m ²)	BX134GG
13.1' x 164' (4.0m x 50.0m)	239 (200m ²)	BX154GG
13.1' x 246' (4.0m x 75.0m)	359 (300 m ²)	BX414GG
13.1' x 328' (4.0m x 100m)	478 (400 m ²)	BX2525GG
13.1' x 328' (4.0m x 100m)	478 (400 m ²)	BX224GG
13.1' x 164' (4.0m x 50m)	239 (200 m ²)	BX40404GG

UNIAXIAL GEOGRIDS



W X L	SY/ROLL	PRODUCT CODE
3.28' x 328' (1 m x 100 m)	120 (100 m ²)	UX11SGG
3.28' x 246' (1 m x 75 m)	90 (75m ²)	UX14SGG
3.28' x 164' (1 m x 50 m)	60 (50m ²)	UX15SGG
3.28' x 99' (1 m x 30 m)	36 (30m ²)	UX16SGG
3.28' x 99' (1 m x 30 m)	36 (30m ²)	UX17SGG

PAVING FABRIC



W X L	SY/ROLL	PRODUCT CODE
12.5' x 360' (3.8m x 109.7m)	500 (418 m ²)	4598TG
15' x 360' (4.6m x 109.7m)	600 (502 m ²)	4598TS
12.5' x 360' (3.8m x 109.7m)	500 (418 m ²)	4599TG
15' x 360' (4.6m x 109.7m)	600 (502 m ²)	4599TS

GEOSYNTHETICS

SEPTIC FABRIC

SPUNBOND



WEIGHT	W X L	SY/ROLL	PRODUCT CODE
1.5 oz. (43 g)	3' x 300' (.9m x 91.4m)	100 (84 m ²)	3151TA
1.5 oz. (43 g)	4' x 300' (1.2m x 91.4m)	133.33 (111 m ²)	3151TB
1.5 oz. (43 g)	6.3' x 300' (1.9m x 91.4m)	208.33 (174 m ²)	3151TE
1.5 oz. (43 g)	12.6' x 300' (3.8m x 91.4m)	420 (351 m ²)	3151TG
2.0 oz. (57 g)	6.3' x 300' (1.9m x 91.4m)	208 (174 m ²)	3201TE
2.0 oz. (57 g)	3' x 300' (.9m x 91.4m)	100 (84 m ²)	3201TA
2.0 oz. (57 g)	4' x 300' (1.2m x 91.4m)	133.33 (111 m ²)	3201TB
2.0 oz. (57 g)	12.6' x 300' (3.8m x 91.4m)	420 (351 m ²)	3201TG
3.0 oz. (85 g)	3' x 300' (.9m x 91.4m)	100 (84 m ²)	3301TA
3.0 oz. (85 g)	4' x 300' (1.2m x 91.4m)	133.33 (111 m ²)	3301TB
3.0 oz. (85 g)	6.3' x 300' (1.9m x 91.4m)	208.33 (174 m ²)	3301TE
3.0 oz. (85 g)	9' x 300' (2.7m x 91.4m)	300 (247 m ²)	3301TT
3.0 oz. (85 g)	12.6' x 300' (3.8m x 91.4m)	420 (351 m ²)	3301TG
4.0 oz. (113 g)	12.6' x 300' (3.8m x 91.4m)	420 (351 m ²)	3401TG
4.0 oz. (113 g)	15.6' x 300' (4.8m x 91.4m)	520 (435 m ²)	3401TH
6.0 oz. (170 g)	3.8' x 300' (3.8m x 91m)	420 (351 m ²)	3601TG
6.0 oz. (170 g)	15.6 x 300' (4.8m x 91m)	520 (435 m ²)	3601TH

SEPTIC FABRIC



WEIGHT	W X L	PRODUCT CODE
0.45 oz. (13 g)	2' x 300' (.6m x 91.4m)	2624RB
0.45 oz. (13 g)	3' x 300' (.9m x 91.4m)	2636RB
0.45 oz. (13 g)	2' x 1500' (.6m x 457.2m)	2724RB
0.45 oz. (13 g)	3' x 1500' (.9m x 457.2m)	2736RB
0.45 oz. (13 g)	4' x 1500' (1.2m x 457.2m)	2748RB
0.45 oz. (13 g)	5' x 1500' (1.5m x 457.2m)	2760RB
0.45 oz. (13 g)	6' x 1500' (1.8m x 457.2m)	2772RB

SEPTIC FABRIC (TX)



WEIGHT	W X L	PRODUCT CODE
0.7 oz. (13 g)	2' x 300' (.6m x 91.4m)	2824RB
0.7 oz. (13 g)	3' x 300' (.9m x 91.4m)	2836RB
0.7 oz. (13 g)	2' x 1500' (.6m x 457.2m)	2924RB
0.7 oz. (13 g)	3' x 1500' (.9m x 457.2m)	2936RB
0.7 oz. (13 g)	4' x 1500' (1.2m x 457.2m)	2948RB
0.7 oz. (13 g)	6' x 1500' (1.8m x 457.2m)	2972RB

GEOSYNTHETICS

BLANKETS, MATS, SILT FENCES, FABRIC PINS

EROSION CONTROL BLANKETS (ECB) - BIODEGRADABLE



W X L	SY/ROLL	DESCRIPTION	PRODUCT CODE
7.8' x 112.5' (2.4m x 34.3m)	100 (84 m ²)	Single net straw	OOS1TT
7.8' x 112.5' (2.4m x 34.3m)	100 (84 m ²)	Double net straw	OOS2TT
7.8' x 112.5' (2.4m x 34.3m)	100 (84 m ²)	Coconut/Straw	OCS2TT
7.8' x 112.5' (2.4m x 34.3m)	100 (84 m ²)	100% Coconut	OOC2TT
7.8' x 112.5' (2.4m x 34.3m)	100 (84 m ²)	Single net straw all natural	OOS1AN
7.8' x 112.5' (2.4m x 34.3m)	100 (84 m ²)	Double net straw all natural	OOS2AN
7.8' x 112.5' (2.4m x 34.3m)	100 (84 m ²)	Coconut/Straw all natural	OCS2AN
7.8' x 112.5' (2.4m x 34.3m)	100 (84 m ²)	100% Coconut all natural	OOC2AN

TURF REINFORCEMENT MAT (TRM) - PERMANENT



SIZE	SY/ROLL	PRODUCT CODE
7.5' x 120' (2.3m x 36.6m)	100 (84 m ²)	PP58GTR
7.5' x 120' (2.3m x 36.6m)	100 (84 m ²)	PP510GTR
7.5' x 120' (2.3m x 36.6m)	100 (84 m ²)	PP512GTR

HIGH PERFORMANCE TURF REINFORCEMENT MAT - PERMANENT



SIZE	SY/ROLL	PRODUCT CODE
8.5' x 109' (2.6m x 42.2m)	100 (84 m ²)	PP5XGTR

FABRIC PINS



SIZE	QUANTITY	PRODUCT CODE
6" (50mm) Staple	1000/box	3206TP
12" (300mm) Pin	100/box	3212TP
18" (457mm) Pin	100/box	3218TP

SILT FENCE



DESCRIPTION	PRODUCT CODE
2' x 100' (.6m x 30m) rolls with 11 hardwood stakes per roll	3301WE
3' x 100' (.9m x 30m) rolls with 11 hardwood stakes per roll	3302WE
Premium Silt Fence - AASHTO 3' x 100' (.9m x 30m) with 17 hardwood stakes per roll	3302WP

OUTFLOW MAT



SIZE	SY/ROLL	PRODUCT CODE
12' x 75' (3.7m x 22.9m)	100 (83.6m ²)	OFM100

ADS "Terms and Conditions of Sale" are available on the ADS website, www.ads-pipe.com.
Advanced Drainage Systems, the ADS logo, the Green Stripe, ADS 3000 TripleWall®, N-12®, AdvanEDGE®, Grain Aire®, Septic Stack™, Duraslot®, LandMax®, SaniTite® HP, MEGA GREEN™, Channel-Flow®, Turf Flow®, Bend-A-Drain™, and ADS PolyFlex™ are registered trademarks of Advanced Drainage Systems, Inc. FLEXSTORIM® and CATCH-IT® are registered trademarks of Inlet & Pipe Protection, Inc. StormTech® is a registered trademark of StormTech, Inc. INSERTA TEE® is a registered trademark of Inserta Fittings, Inc. Nyloplast® and EnviroHood™ are registered trademarks of Nyloplast, Inc. Arc™ and Biodiffuser® are registered trademarks of ISI. Hickenbottom® is a registered trademark of Hickenbottom, Inc. BayFilter™ BaySeparator™ and Barracuda™ are registered trademarks of BaySaver Technologies® LLC. Mar Mac® is a registered trademark of Mar Mac Construction Products Co., Inc.
© 2019 Advanced Drainage Systems, Inc. BRO #10524 04/19 MH



Innovation in product, process and technology. *That's ADS.*

Beginning with single wall corrugated polyethylene pipe, ADS has continually introduced drainage products that have set the industry standard. Our commitment to being the best means that we continue to refine the structural design of our pipe and redefine the limits of its application in the structural design community.

Advanced Drainage Systems, Inc.
4640 Trueman Blvd. Hilliard, OH 43026
1-800-821-6710
www.ads-pipe.com

THE MOST **ADVANCED** NAME IN WATER MANAGEMENT SOLUTIONS™

